

南京诺金电气有限公司

Nanjing Nowking Electric Co., Ltd

USB 端口保护盖样本



产品名称：USB 端口保护盖

规格型号：USB-C1

◆ MATERIAL:ABS(UL)

◆ COLOR:94HB

◆ COLOR:BLACK

◆ UNIT:mm

用途: 用于 USB 接头之防尘与保护用

USB-C1 结构图

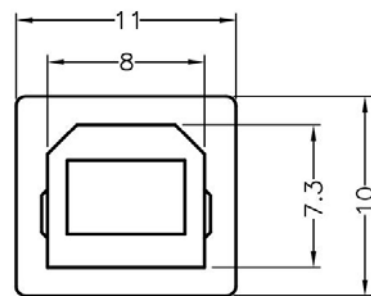
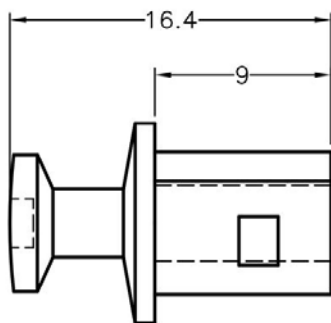

	PART NO	PACKAGE
	USB-C1	1000

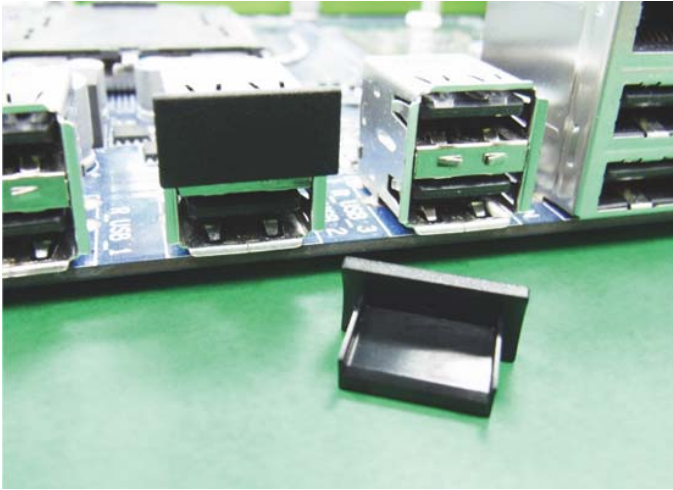

产品名称：USB 端口保护盖

规格型号：USB-C2

- ◆ MATERIAL:ABS(UL)
- ◆ COLOR:94HB
- ◆ COLOR:BLACK,NATURAL,WHITE
- ◆ UNIT:mm

用途：用于 USB 接头之防尘与保护用

所有尺寸量测皆不含进胶口,胶口凸出 0.3mm 之内

USB-C2 结构图

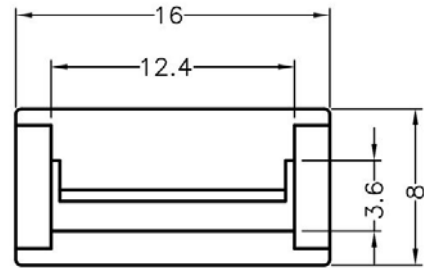
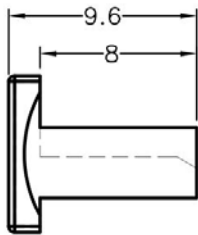

	PART NO	PACKAGE
	USB-C2	1000



产品名称：USB 端口保护盖

规格型号：USB-C3

- ◆ MATERIAL:PP(UL)
- ◆ COLOR:94HB
- ◆ COLOR:BLACK
- ◆ UNIT:mm

用途：用于 USB 接头之防尘与保护用

所有尺寸量测皆不含进胶口,胶口凸出 0.3mm 之内

USB-C3 结构图

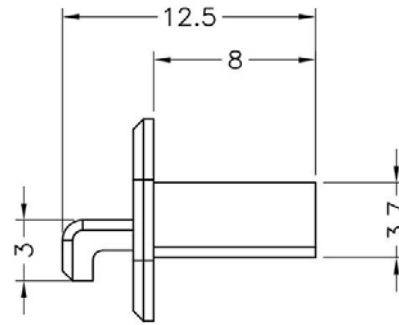
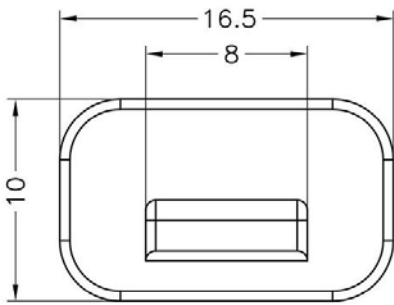

	PART NO	PACKAGE
	USB-C3	1000



产品名称：USB 端口保护盖

规格型号：USB-C4

- ◆ MATERIAL:ABS(UL)
- ◆ COLOR:94HB
- ◆ COLOR:BLACK
- ◆ UNIT:mm

用途：用于 USB 接头之防尘与保护用

所有尺寸量测皆不含进胶口,胶口凸出 0.3mm 之内

USB-C4 结构图

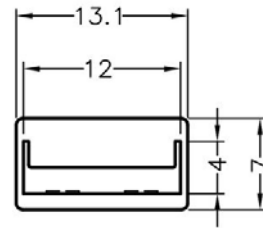
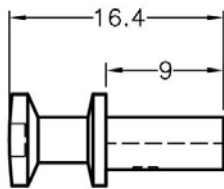

	PART NO	PACKAGE
	USB-C4	1000



产品名称：USB 端口保护盖

规格型号：USB-C5

- ◆ MATERIAL:PP(UL)
- ◆ COLOR:BLACK,COMPUTER
- ◆ UNIT:mm

用途：用于 USB 接头之防尘与保护用

所有尺寸量测皆不含进胶口,胶口凸出 0.3mm 之内

USB-C5 结构图

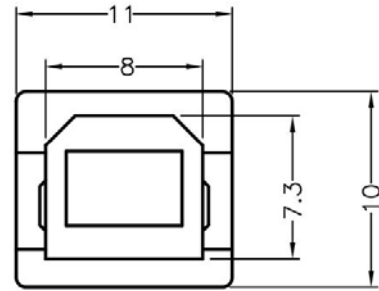
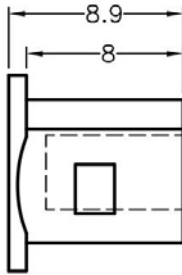

	PART NO	PACKAGE
	USB-C5	1000

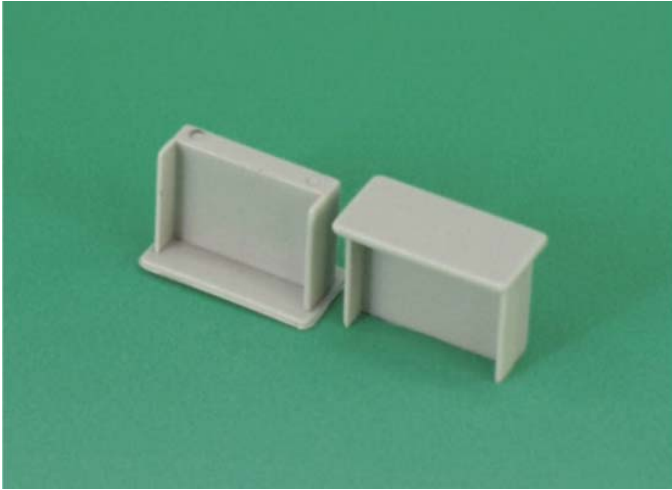

产品名称：USB 端口保护盖

规格型号：USB-C6

- ◆ MATERIAL:PP(UL)
- ◆ COLOR:BLACK,COMPUTER
- ◆ UNIT:mm

用途：用于 USB 接头之防尘与保护用

所有尺寸量测皆不含进胶口,胶口凸出 0.3mm 之内

USB-C6 结构图

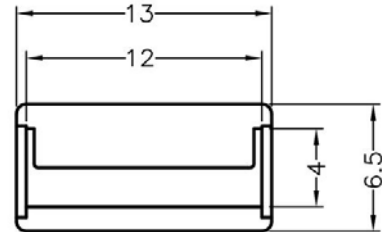
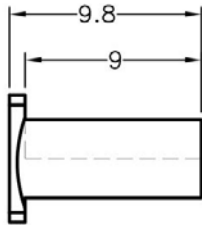

	PART NO	PACKAGE
	USB-C6	1000

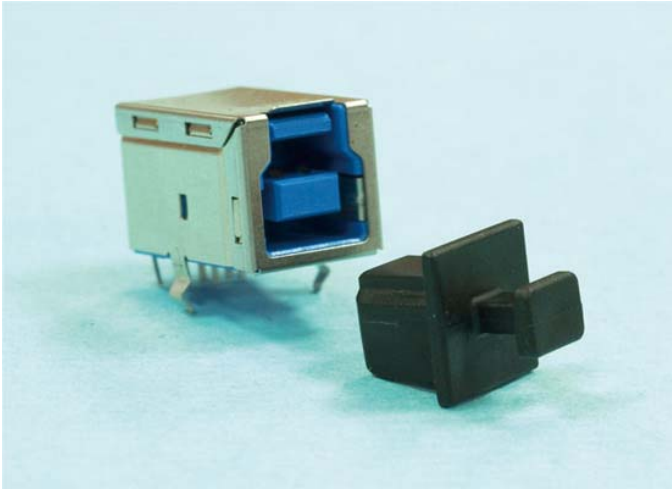

产品名称：USB 端口保护盖

规格型号：USB-C7

◆ MATERIAL:PP(UL)

◆ COLOR:BLACK

◆ UNIT:mm

用途：用于 USB 接头之防尘与保护用

可使用同等材质

USB-C7 结构图

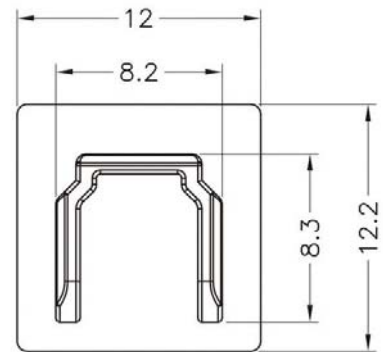
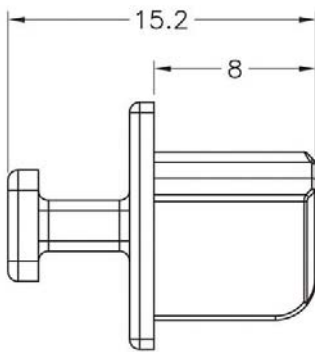

	PART NO	PACKAGE
	USB-C7	1000



产品名称：USB 端口保护盖

规格型号：USB-C8

- ◆ MATERIAL: NYLON 66(UL)
- ◆ FLAME CLASS: 94V-0, 94V-2
- ◆ COLOR: BLACK, NATURAL
- ◆ UNIT: mm

用途：用于 USB 接头之防尘与锁定。

所有尺寸量测皆不含进胶口, 胶口凸出 0.3mm 之内

USB-C8 结构图

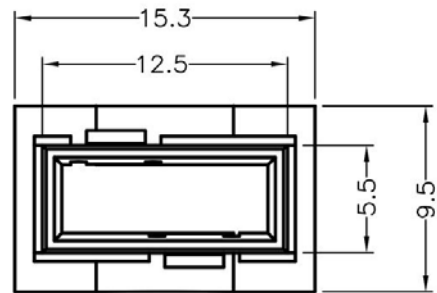
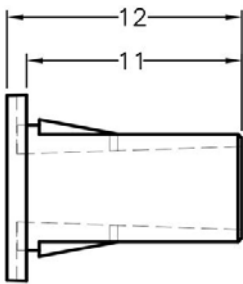

	PART NO	PACKAGE
	USB-C8	1000

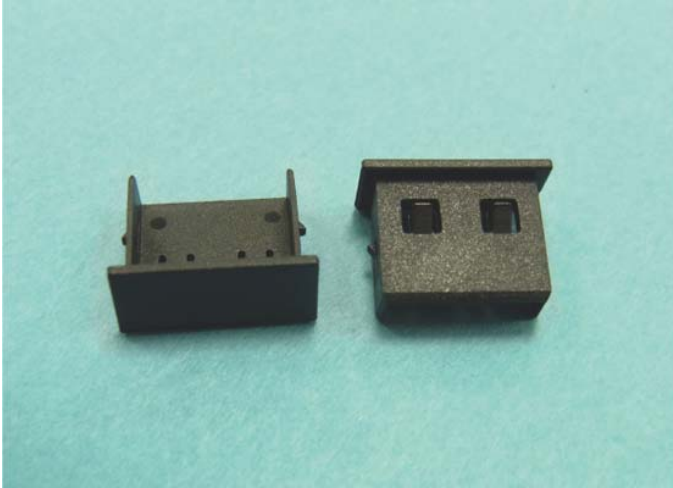

产品名称：USB 端口保护盖

规格型号：USB-C9

- ◆ MATERIAL: NYLON 66(UL)
- ◆ FLAME CLASS: 94V-0, 94V-2
- ◆ COLOR: BLACK, NATURAL
- ◆ UNIT: mm

用途：用于重要的 USB 接头的堵塞，避免重要资料泄漏。拔取困难，兼具防尘与保护。

所有尺寸量测皆不含进胶口，胶口凸出 0.3mm 之内

USB-C9 结构图

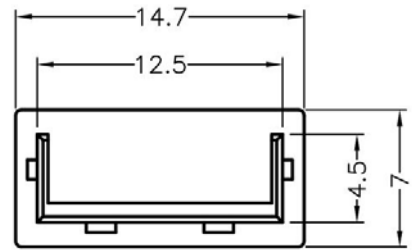
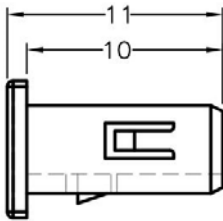

	PART NO	PACKAGE
	USB-C9	1000

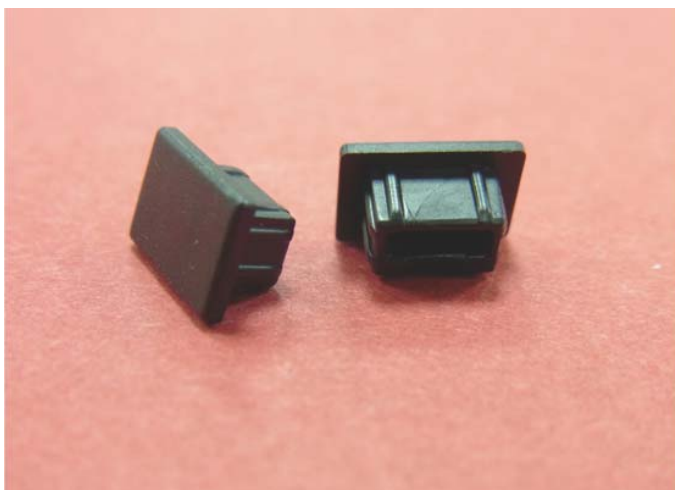

产品名称：MINI USB 端口保护盖

规格型号：USB-C10

- ◆ MATERIAL:PP(UL)
- ◆ FLAME CLASS:94HB
- ◆ COLOR:BLACK
- ◆ UNIT:mm

用途：用于 MINI USB 接头的防尘和保护。

所有尺寸量测皆不含进胶口,胶口凸出 0.3mm 之内

USB-C10 结构图

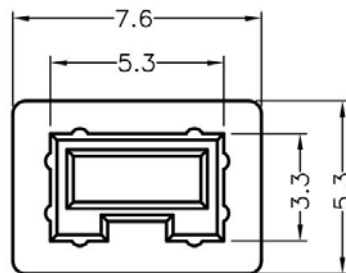
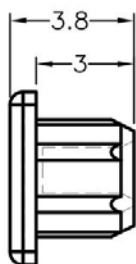

	PART NO	PACKAGE
	USB-C10	1000



产品名称：USB 端口保护盖

规格型号：USB-C11

- ◆ MATERIAL: NYLON 66(UL)
- ◆ FLAME CLASS: 94V-0, 94V-2
- ◆ COLOR: BLACK, NATURAL
- ◆ UNIT: mm

用途：用于 USB 接头的防尘和保护。

所有尺寸量测皆不含进胶口, 胶口凸出 0.3mm 之内

USB-C11 结构图

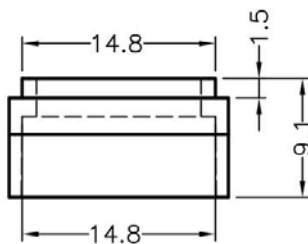
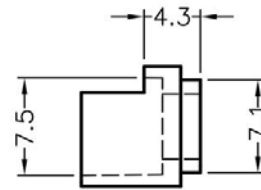
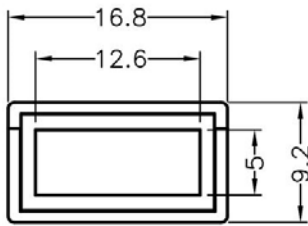

PART NO	PACKAGE
USB-C11	1000

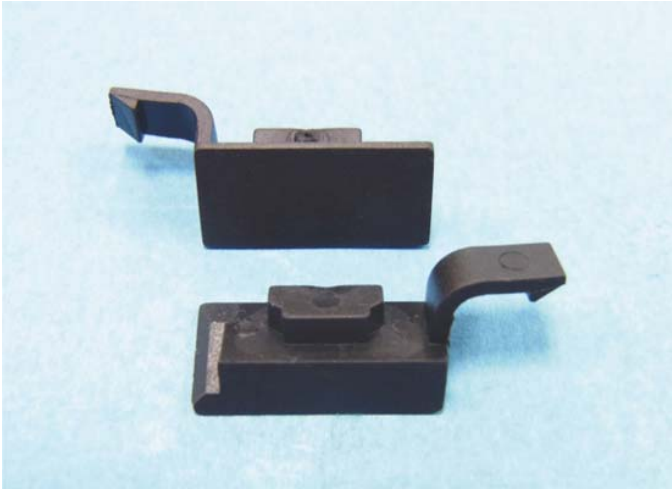

产品名称：USB 端口保护盖

规格型号：USB-C12

◆ MATERIAL:TPE

◆ COLOR:BLACK

◆ UNIT:mm

用途：用于 USB 接头的防尘和保护。

所有尺寸量测皆不含进胶口,胶口凸出 0.3mm 之内

USB-C12 结构图

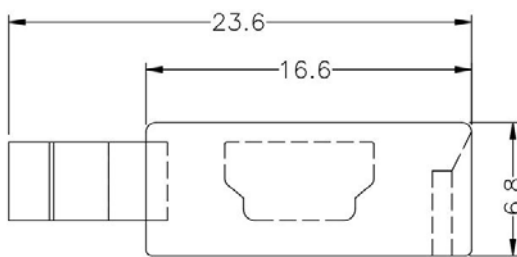
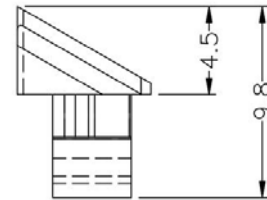
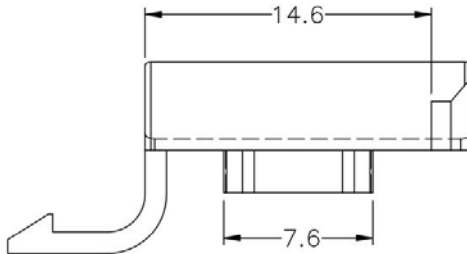

	PART NO	PACKAGE
	USB-C12	1000

南京诺金电气有限公司

Nanjing Nowking Electric Co., Ltd



产品名称：USB3.0 端口保护盖

规格型号：USB-C13

◆ MATERIAL:TPE

◆ COLOR:BLACK

◆ UNIT:mm

用途：用于 USB 3.0 接头的防尘和保护。

所有尺寸量测皆不含进胶口,胶口凸出 1.2mm 之内

USB-C13 结构图

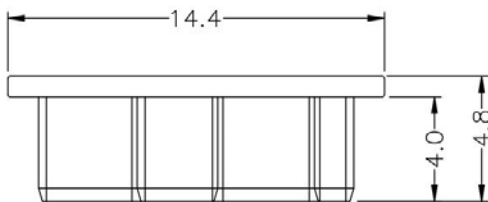
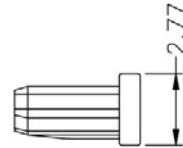
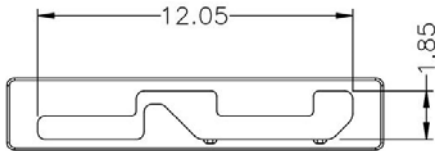

	PART NO	PACKAGE
	USB-C13	1000

总机/TEL:+86 25 85422485 85437901 85436028
传真/FAX:+86 25 85420612
<http://www.nowking.com> E-mail: nk@nowking.com
QQ: 260678075

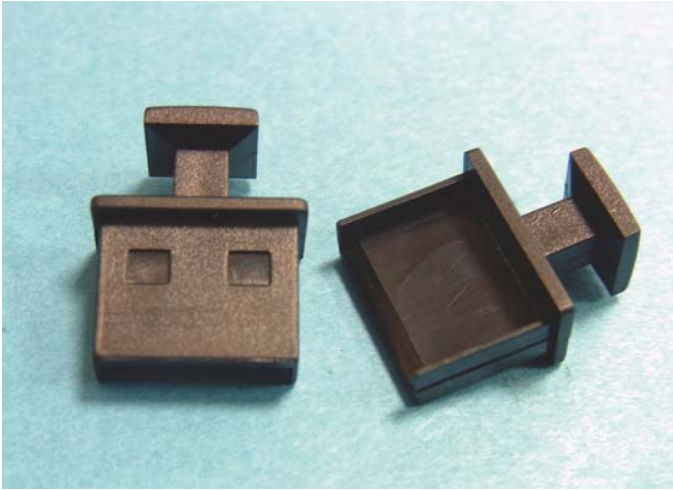

产品名称：USB 端口保护盖

规格型号：USB-C14

- ◆ MATERIAL:ABS(UL)
- ◆ FLAME CLASS:94HB
- ◆ COLOR:BLACK
- ◆ UNIT:mm

用途：用于 USB 接头的防尘和保护。

所有尺寸量测皆不含进胶口,胶口凸出 0.3mm 之内

USB-C14 结构图

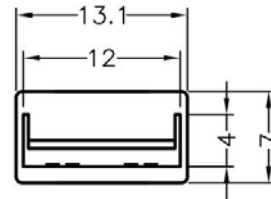
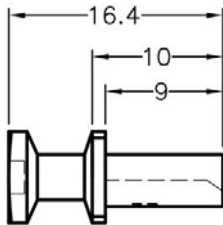

	PART NO	PACKAGE
	USB-C14	1000

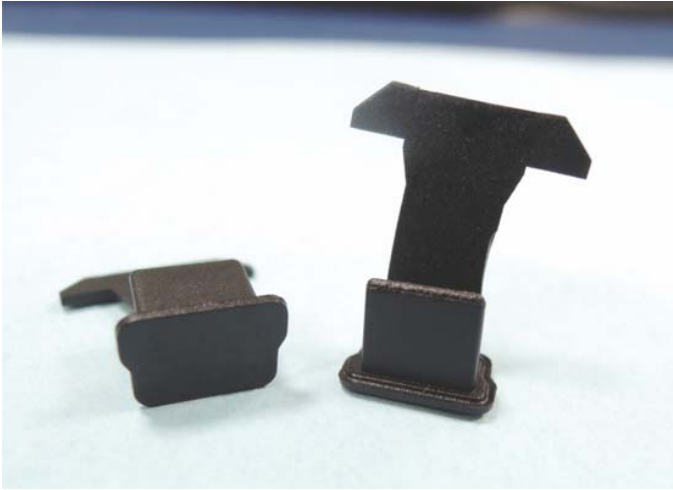

产品名称：USB 端口保护盖

规格型号：USB-C15

◆ MATERIAL:TPU

◆ COLOR:BLACK

◆ UNIT:mm

用途：用于 USB 接头的防尘和保护。

所有尺寸量测皆不含进胶口,胶口凸出 1.2mm 之内

USB-C15 结构图

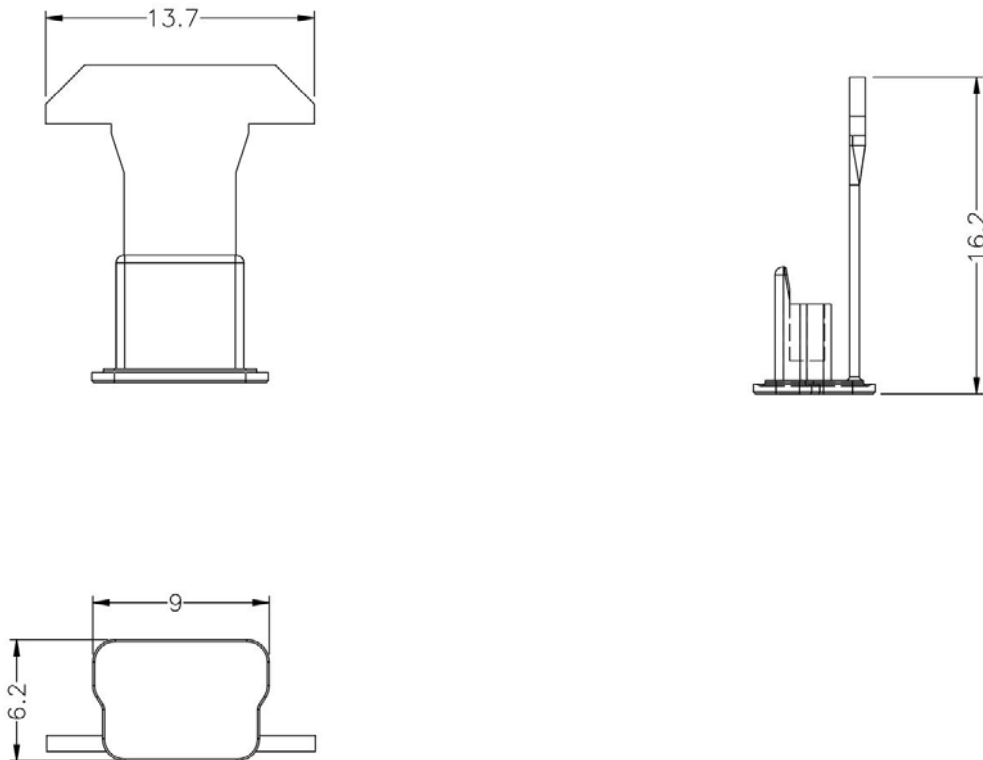

	PART NO	PACKAGE
	USB-C15	1000

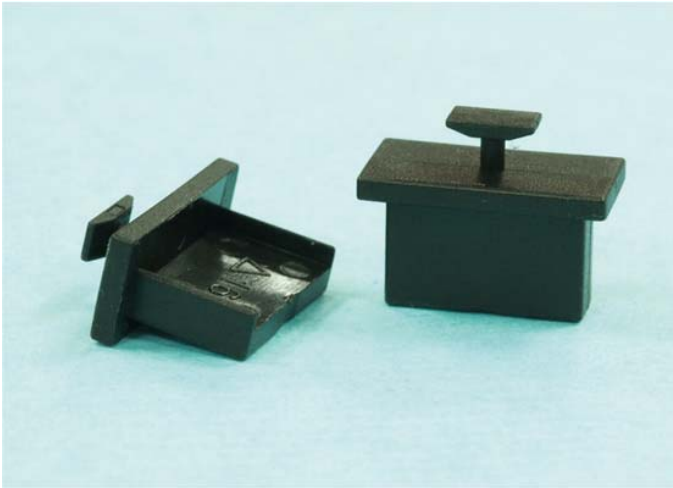

产品名称：USB 端口保护盖

规格型号：USB-C16

- ◆ MATERIAL:PP(UL)
- ◆ FLAME CLASS:94HB
- ◆ COLOR:BLACK
- ◆ UNIT:mm

用途：用于 USB 接头的防尘和保护。
可使用同等材质

USB-C16 结构图

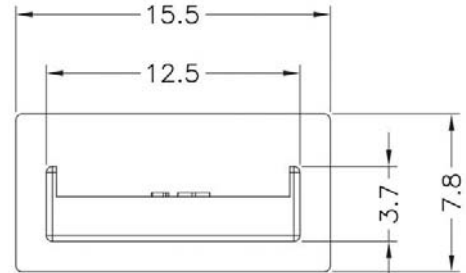
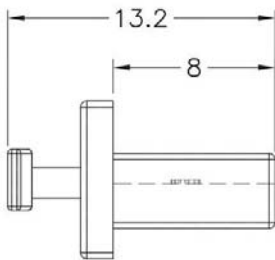

	PART NO	PACKAGE
	USB-C16	1000

产品名称：MINI USB 端口保护盖



规格型号：USB-C17

- ◆ MATERIAL:TPE
- ◆ COLOR:BLACK
- ◆ UNIT:mm

用途：用于 MINI USB 接头的防尘和保护。

所有尺寸量测皆不含进胶口,胶口凸出 1.2mm 之内

USB-C17 结构图

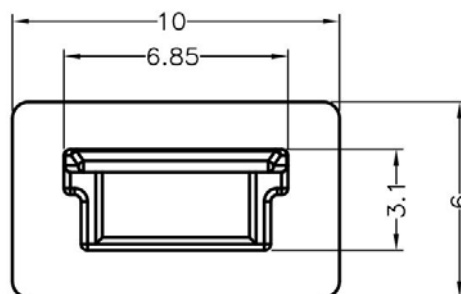
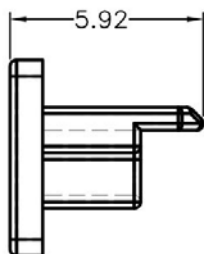

	PART NO	PACKAGE
	USB-C17	1000



产品名称：MINI USB 端口保护盖

规格型号：USB-C18

◆MATERIAL:TPE

◆COLOR:BLACK

◆UNIT:mm

用途：用于 MINI USB 接头的防尘和保护。

所有尺寸量测皆不含进胶口,胶口凸出 1.2mm 之内

USB-C18 结构图

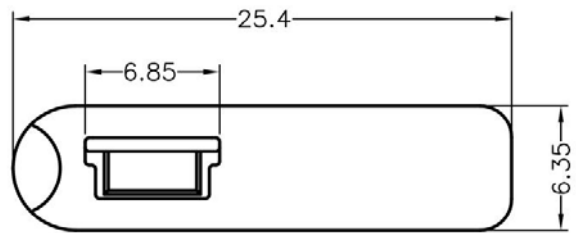
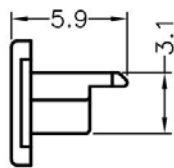

	PART NO	PACKAGE
	USB-C18	1000



产品名称：MINI USB 端口保护盖

规格型号：USB-C19

- ◆ MATERIAL:TPE
- ◆ COLOR:BLACK
- ◆ UNIT:mm

用途：用于 MINI USB 接头的防尘和保护。

所有尺寸量测皆不含进胶口,胶口凸出 1.2mm 之内

USB-C19 结构图

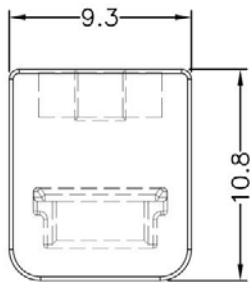
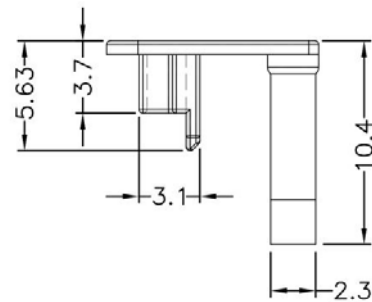
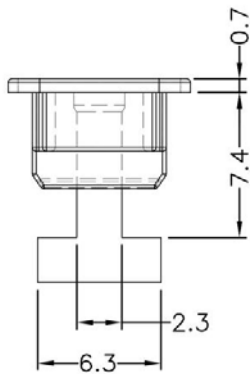

PART NO	PACKAGE
USB-C19	1000

南京诺金电气有限公司

Nanjing Nowking Electric Co., Ltd

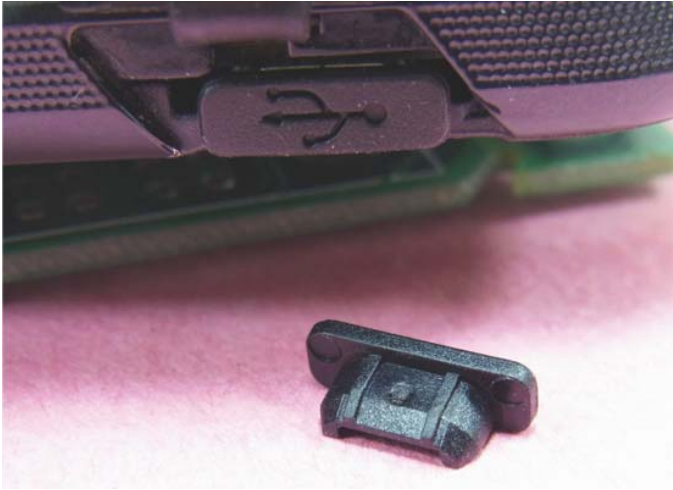

产品名称：MICRO USB 端口保护盖

规格型号：USB-C20

- ◆ MATERIAL:TPE
- ◆ COLOR:BLACK
- ◆ UNIT:mm

用途: 用于 MICRO USB 接头的防尘和保护。

所有尺寸量测皆不含进胶口,胶口凸出 1.2mm 之内

USB-C20 结构图

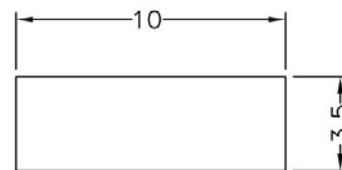
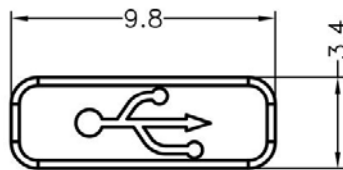
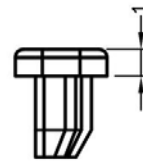
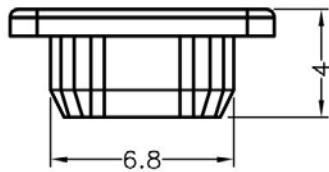

MOUNTING HOLE

PART NO	PACKAGE
USB-C20	1000

总机/TEL:+86 25 85422485 85437901 85436028
 传真/FAX:+86 25 85420612
<http://www.nowking.com> E-mail: nk@nowking.com
 QQ: 260678075

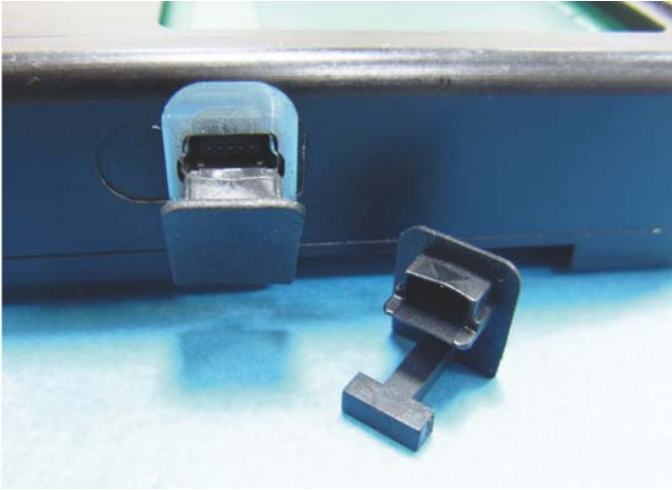

产品名称：MINI USB 端口保护盖

规格型号：USB-C21

◆ MATERIAL:TPE

◆ COLOR:BLACK

◆ UNIT:mm

用途：用于 MINI USB 接头的防尘和保护。

USB-C21 结构图

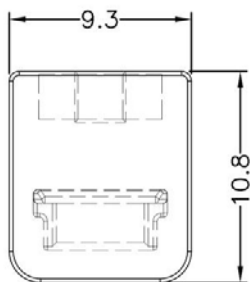
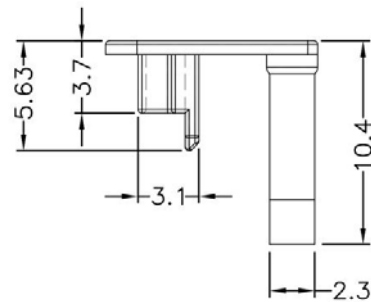
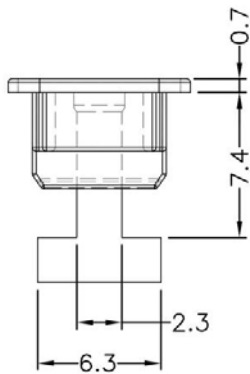

	PART NO	PACKAGE
	USB-C21	1000

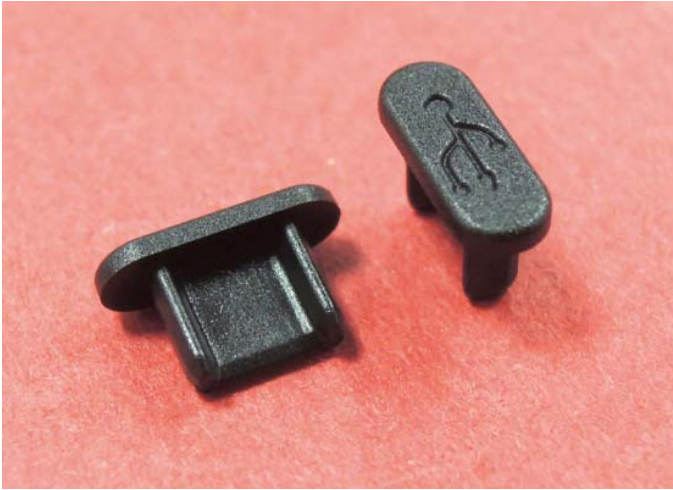

产品名称：MICRO USB 端口保护盖

规格型号：USB-C22

◆ MATERIAL:TPE(UL)

◆ COLOR:BLACK

◆ UNIT:mm

用途：用于 MICRO USB 接头的防尘和保护。

USB-C22 结构图

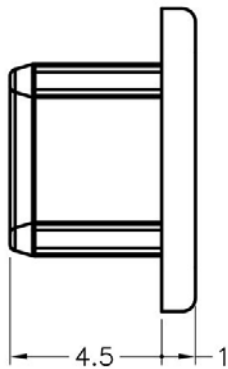
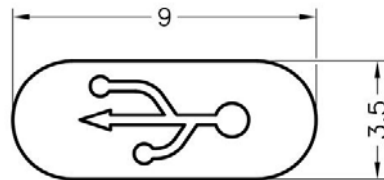
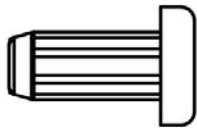

	PART NO	PACKAGE
	USB-C22	1000

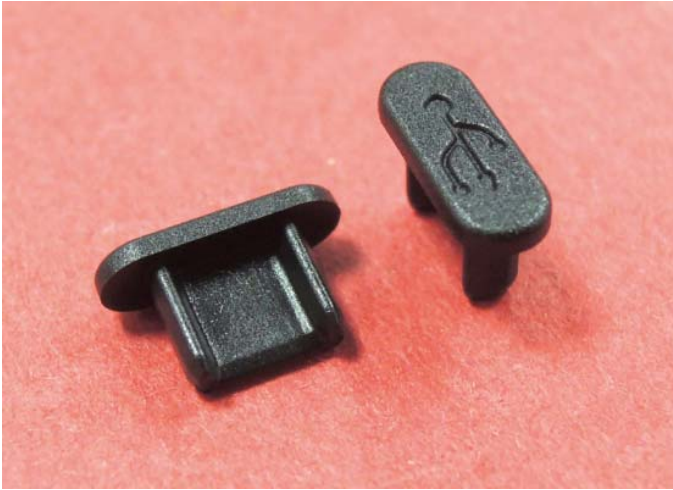

产品名称：MICRO USB 端口保护盖

规格型号：USB-C23

- ◆ MATERIAL:TPE(UL)
- ◆ FLAME CLASS:94V-0
- ◆ COLOR:BLACK
- ◆ UNIT:mm

用途：用于 MICRO USB 接头的防尘和保护。

USB-C23 结构图

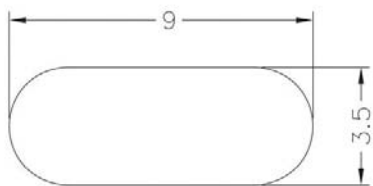
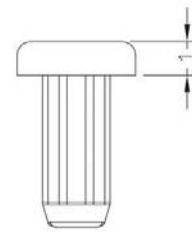
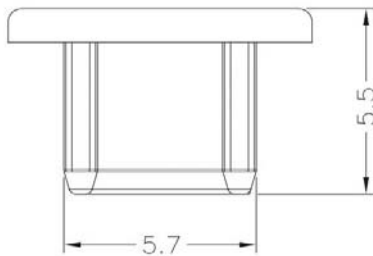

	PART NO	PACKAGE
	USB-C23	1000