

南京诺金电气有限公司

Nanjing Nowking Electric Co., Ltd

防尘盖样本

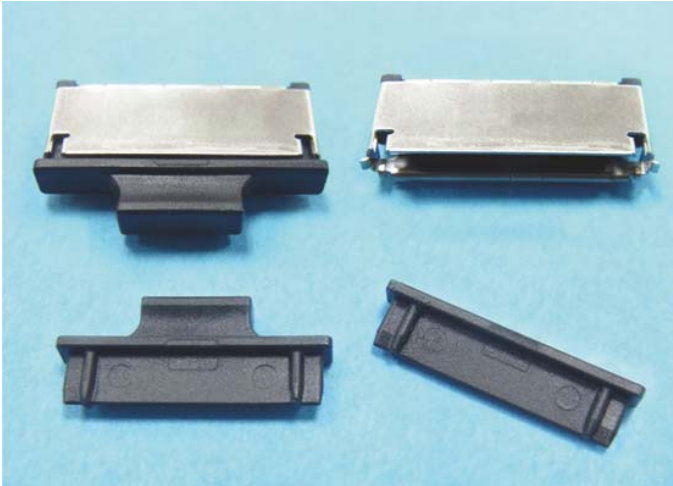

产品名称：防尘盖

规格型号：GFR-1

◆ MATERIAL: PE

◆ COLOR: BLACK, NATURAL

◆ UNIT: mm

用途：用于 KVM 连接器之防尘与保护。

所有尺寸量测皆不含进胶口, 胶口凸出 0.3mm 之内

GFR-1 结构图

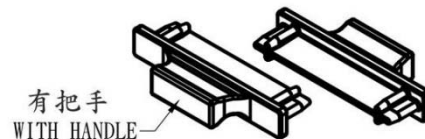
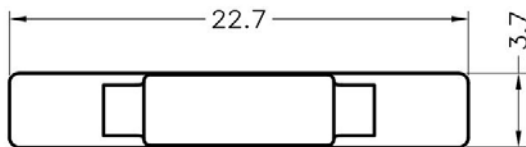
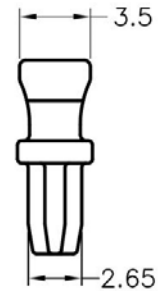
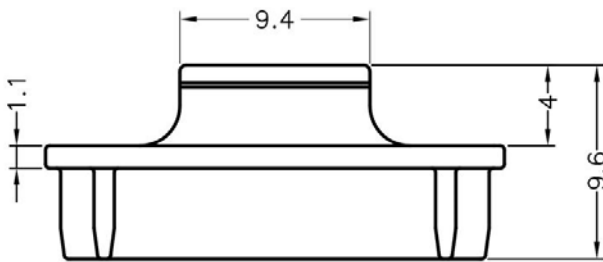

GFR-1

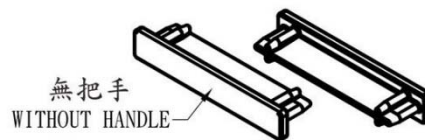

GFR-2

	PART NO	PACKAGE
	GFR-1	1000

南京诺金电气有限公司

Nanjing Nowking Electric Co., Ltd



产品名称：防尘盖

规格型号：GFR-2

◆ MATERIAL: PE

◆ COLOR: BLACK, NATURAL

◆ UNIT: mm

用途：用于 KVM 连接器之防尘与保护。

所有尺寸量测皆不含进胶口, 胶口凸出 0.3mm 之内

GFR-2 结构图

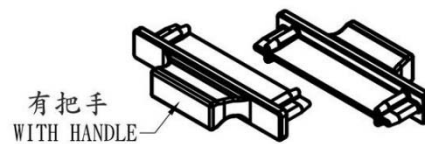
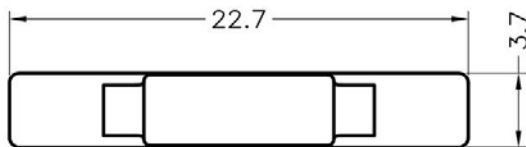
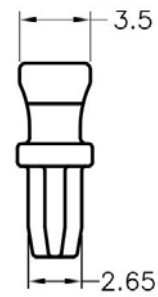
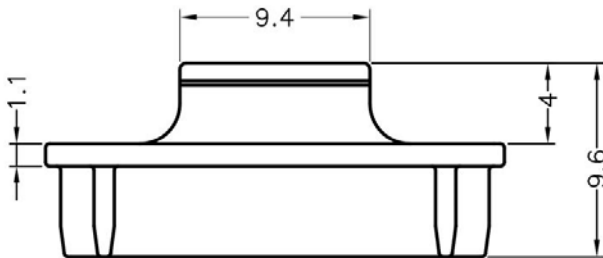

GFR-1

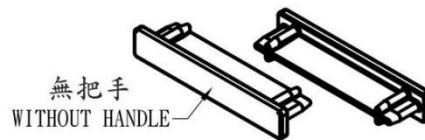

GFR-2

	PART NO	PACKAGE
	GFR-2	1000

南京诺金电气有限公司

Nanjing Nowking Electric Co., Ltd

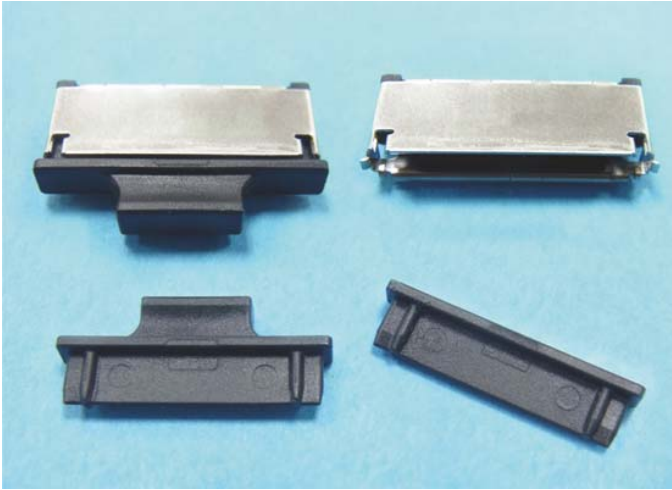

产品名称：防尘盖

规格型号：GFR-3

◆ MATERIAL: PE

◆ COLOR: BLACK, NATURAL

◆ UNIT: mm

用途：用于 KVM 连接器之防尘与保护。

所有尺寸量测皆不含进胶口, 胶口凸出 1.2mm 之内

GFR-3 结构图

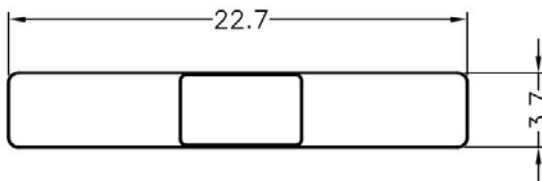
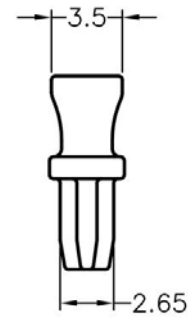
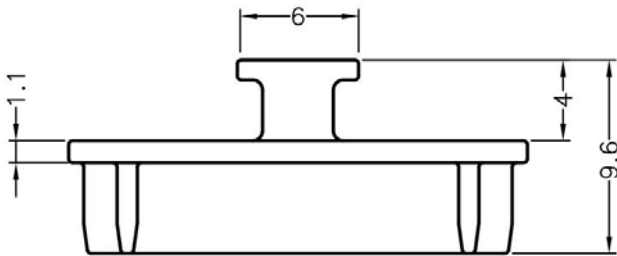

	PART NO	PACKAGE
	GFR-3	1000

南京诺金电气有限公司

Nanjing Nowking Electric Co., Ltd



产品名称: 防尘盖

规格型号: GFR-4

- ◆ MATERIAL: NYLON 66(UL)
- ◆ FLAME CLASS: 94V-0, 94V-2
- ◆ COLOR: BLACK, NATURAL
- ◆ UNIT: mm

用途: 用于机板上, 保护电源插座, 避免刮伤。

GFR-4 结构图

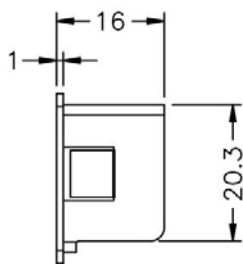
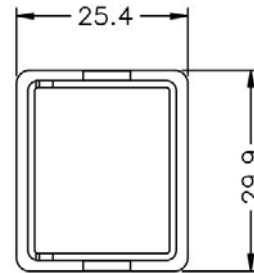
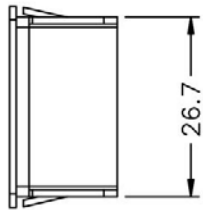

	PART NO	PACKAGE
	GFR-4	1000

南京诺金电气有限公司

Nanjing Nowking Electric Co., Ltd



产品名称：防尘盖

规格型号：GFR-5

◆ MATERIAL: NBR

◆ COLOR: BLACK

◆ UNIT: mm

用途：用于连接器防尘与保护用。

所有尺寸量测皆不含进胶口,胶口凸出 1.2mm 之内

GFR-5 结构图

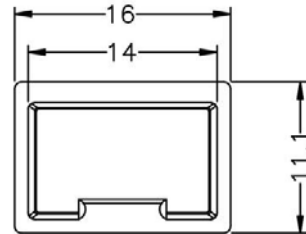
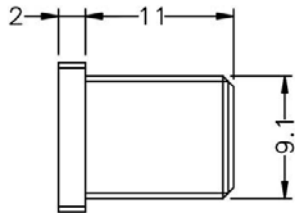

	PART NO	PACKAGE
	GFR-5	1000

南京诺金电气有限公司

Nanjing Nowking Electric Co., Ltd



产品名称：防尘盖

规格型号：GFR-6

◆ MATERIAL: PE

◆ COLOR: BLACK, NATURAL, WHITE

◆ UNIT: mm

用途：用于连接器防尘与保护用。

可使用同等材质

GFR-6 结构图

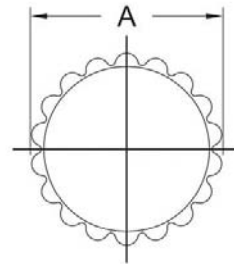
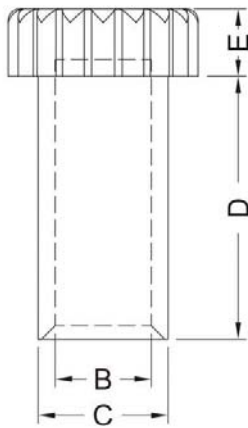

PART NO	A	B	C	D	E	PACKAGE
GFR-6	4.5	2.3	3.3	3.5	3.2	1000

南京诺金电气有限公司

Nanjing Nowking Electric Co., Ltd



产品名称：防尘盖

规格型号：GFR-7

- ◆ MATERIAL: NYLON 66(UL)
- ◆ FLAME CLASS: 94V-0, 94V-2
- ◆ COLOR: BLACK, NATURAL
- ◆ UNIT: mm

用途：用于零件绝缘。

GFR-7 结构图

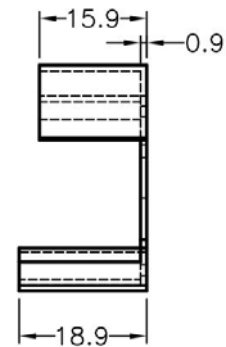
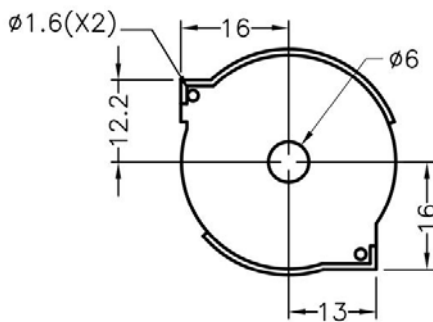

	PART NO	PACKAGE
	GFR-7	1000

南京诺金电气有限公司

Nanjing Nowking Electric Co., Ltd



产品名称：防尘盖

规格型号：GFR-8

- ◆ MATERIAL: NYLON 66(UL)
- ◆ FLAME CLASS: 94V-0, 94V-2
- ◆ COLOR: BLACK, NATURAL
- ◆ UNIT: mm

用途：用于塑胶机壳螺丝孔之塞头。

GFR-8 结构图

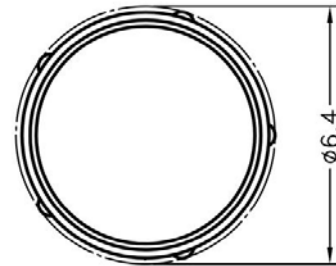
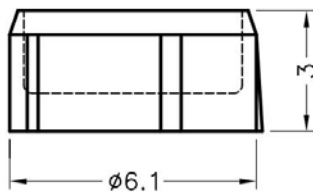

	PART NO	PACKAGE
	GFR-8	2000

南京诺金电气有限公司

Nanjing Nowking Electric Co., Ltd

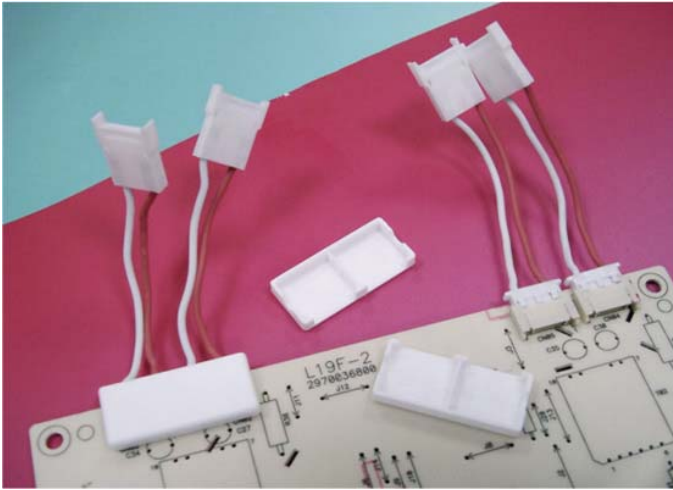

产品名称：防尘盖

规格型号：GFR-9

- ◆ MATERIAL: NYLON 66(UL)
- ◆ FLAME CLASS: 94V-0, 94V-2
- ◆ COLOR: BLACK, NATURAL
- ◆ UNIT: mm

用途：用于连接器防尘与保护用。

GFR-9 结构图

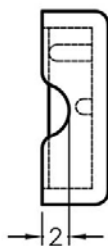
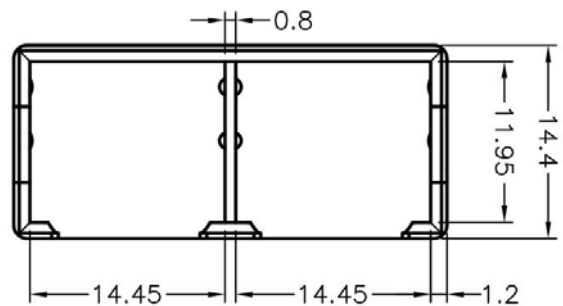
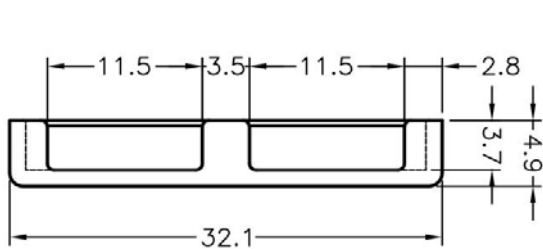

PART NO	PACKAGE
GFR-9	500

南京诺金电气有限公司

Nanjing Nowking Electric Co., Ltd

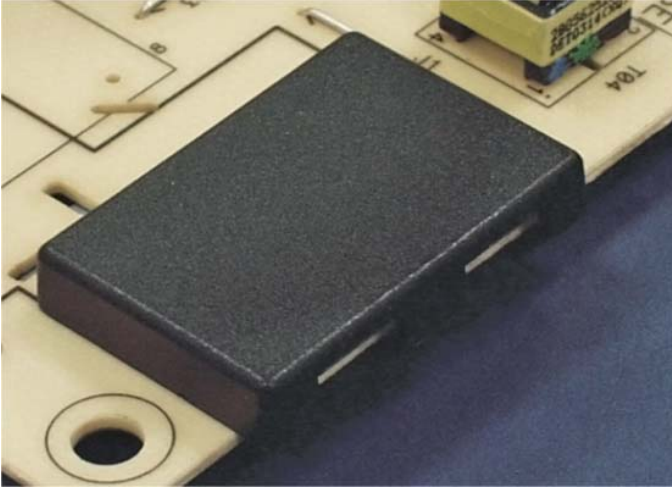

产品名称：防尘盖

规格型号：GFR-10

- ◆ MATERIAL: NYLON 66(UL)
- ◆ FLAME CLASS: 94V-0, 94V-2
- ◆ COLOR: BLACK, NATURAL
- ◆ UNIT: mm

用途：用于连接器防尘与保护用。

GFR-10 结构图

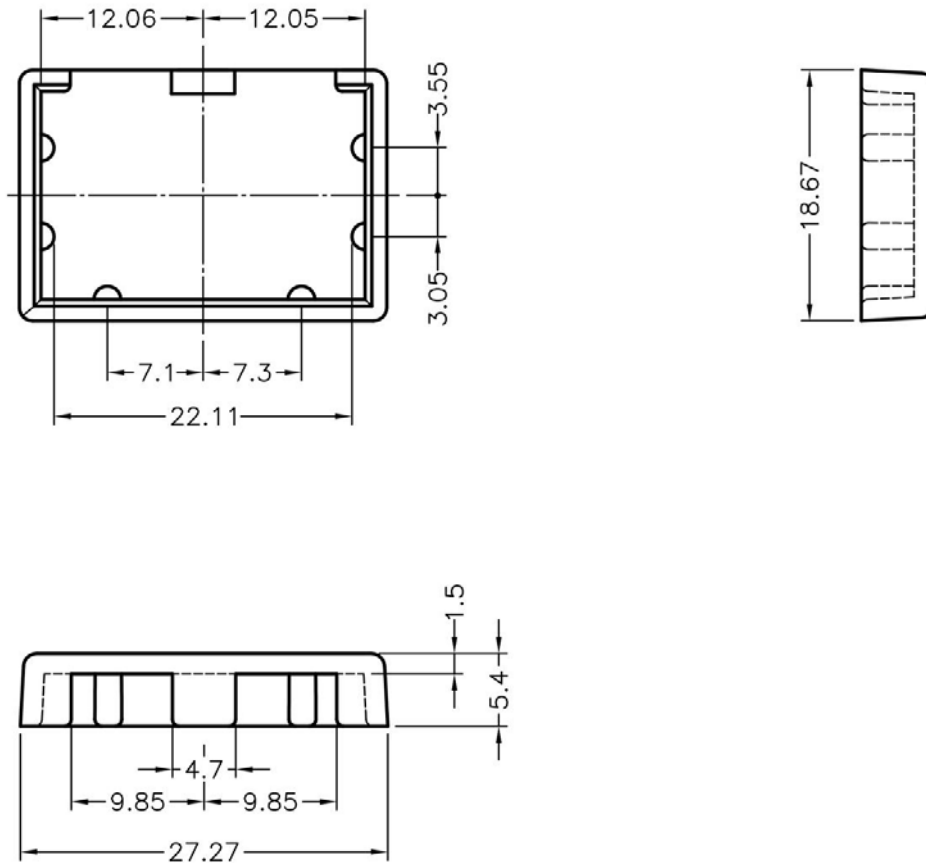

	PART NO	PACKAGE
	GFR-10	500

南京诺金电气有限公司

Nanjing Nowking Electric Co., Ltd

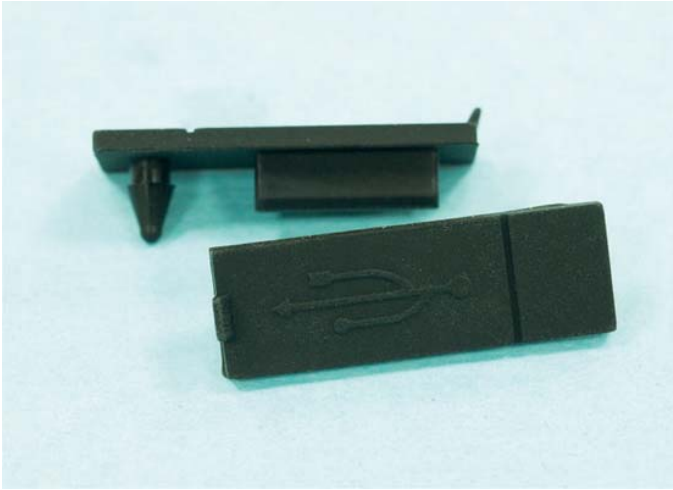

产品名称：防尘盖

规格型号：GFR-11

◆ MATERIAL: SILICON RUBBER

◆ COLOR: BLACK

◆ UNIT: mm

用途：用于 USB 接头防尘与保护用。

GFR-11 结构图

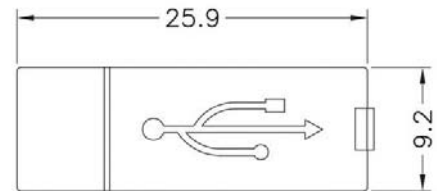
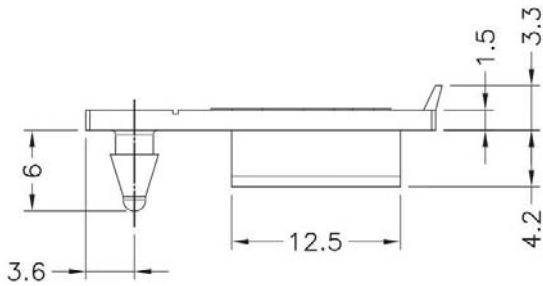

	PART NO	PACKAGE
	GFR-11	1000

南京诺金电气有限公司

Nanjing Nowking Electric Co., Ltd



产品名称：防尘盖

规格型号：GFR-12

◆MATERIAL: PE

◆COLOR:BLACK

◆UNIT: mm

用途：用于 USB 3.0 TYPE-C 接头防尘与保护用。

可使用同等材质

GFR-12 结构图

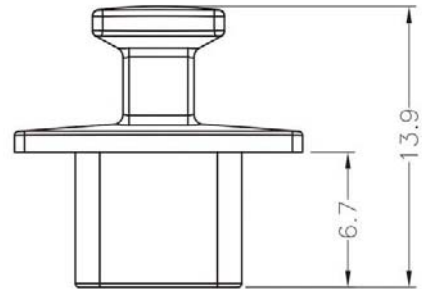
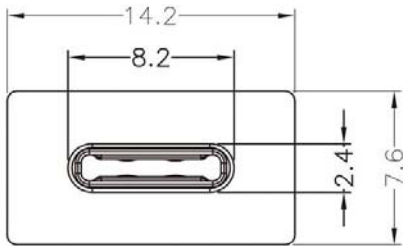

	PART NO	PACKAGE
	GFR-12	1000

南京诺金电气有限公司

Nanjing Nowking Electric Co., Ltd

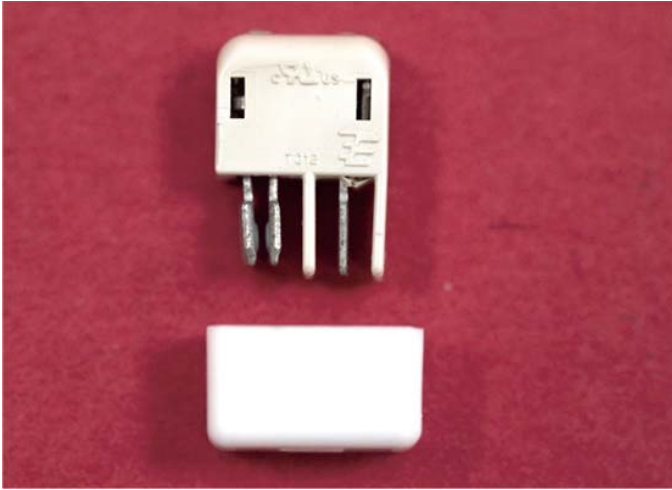

产品名称：防尘盖

规格型号：GFR-13

- ◆ MATERIAL: PTB(UL)
- ◆ FLAME CLASS: 94V-0
- ◆ COLOR: NATURAL
- ◆ UNIT: mm

用途：用于连接器防尘与保护用。

可使用同等材质

GFR-13 结构图

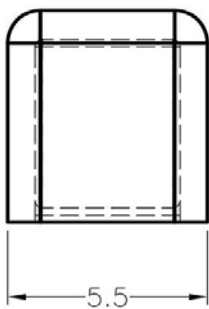
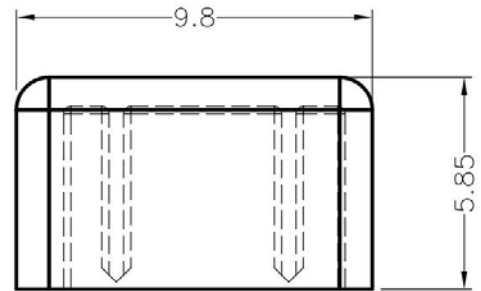
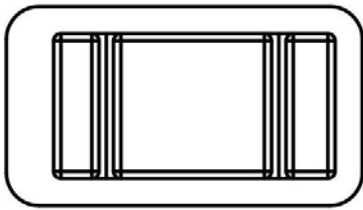

PART NO	PACKAGE
GFR-13	1000

南京诺金电气有限公司

Nanjing Nowking Electric Co., Ltd

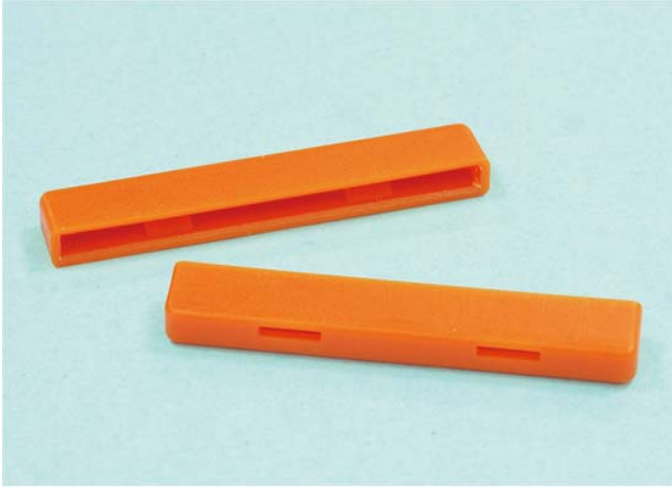

产品名称：防尘盖

规格型号：GFR-14

◆ MATERIAL: PC+ABS(UL)

◆ FLAME CLASS: 94V-0

◆ COLOR: ORANGE

◆ UNIT: mm

用途：用于 PC 板金手指防尘与保护用。

可使用同等材质

内缩为正常现象

GFR-14 结构图

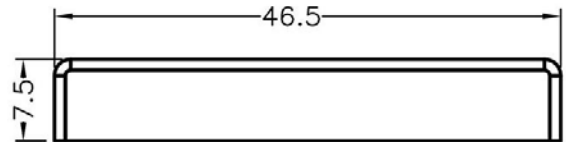
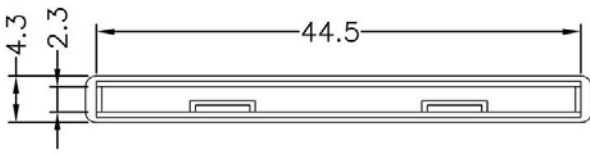

	PART NO	PACKAGE
	GFR-14	1000

南京诺金电气有限公司

Nanjing Nowking Electric Co., Ltd

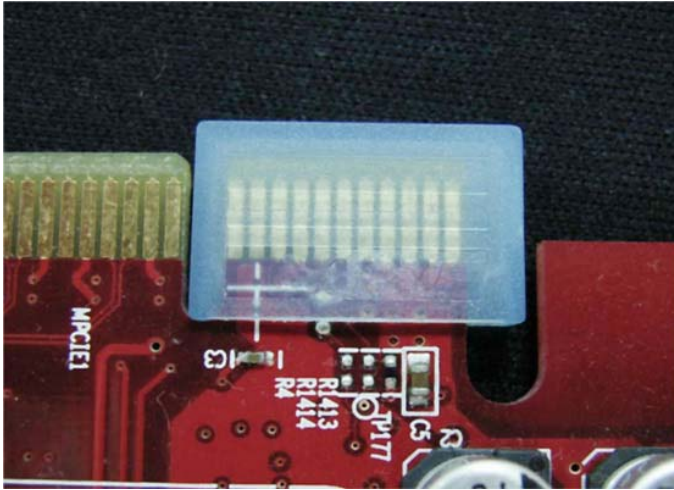

产品名称：防尘盖

规格型号：GFR-15

◆ MATERIAL: PE

◆ COLOR: NATURAL, TRANSPARENT, BLUE

◆ UNIT: mm

用途：用于 PC 板金手指防尘与保护用。

GFR-15 结构图

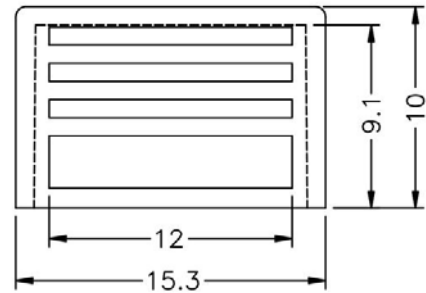
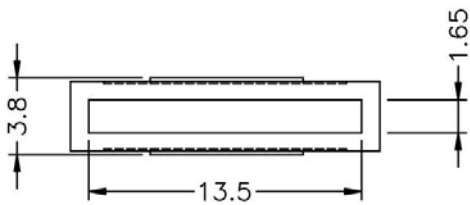

	PART NO	PACKAGE
	GFR-15	2000

南京诺金电气有限公司

Nanjing Nowking Electric Co., Ltd

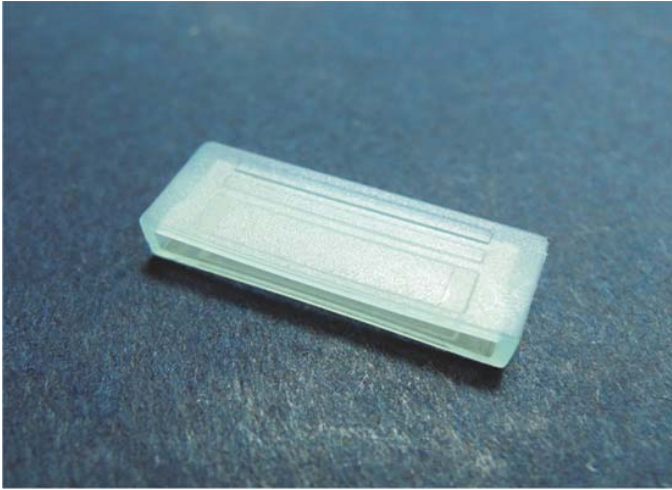

产品名称：防尘盖

规格型号：GFR-16

◆ MATERIAL: PE

◆ COLOR: TRANSPARENT, BLUE

◆ UNIT: mm

用途：用于 PC 板金手指防尘与保护用。

GFR-16 结构图

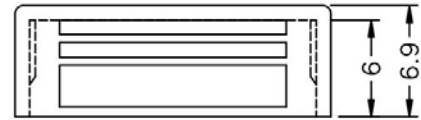
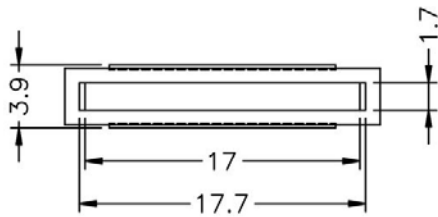

	PART NO	PACKAGE
	GFR-16	2000

南京诺金电气有限公司

Nanjing Nowking Electric Co., Ltd

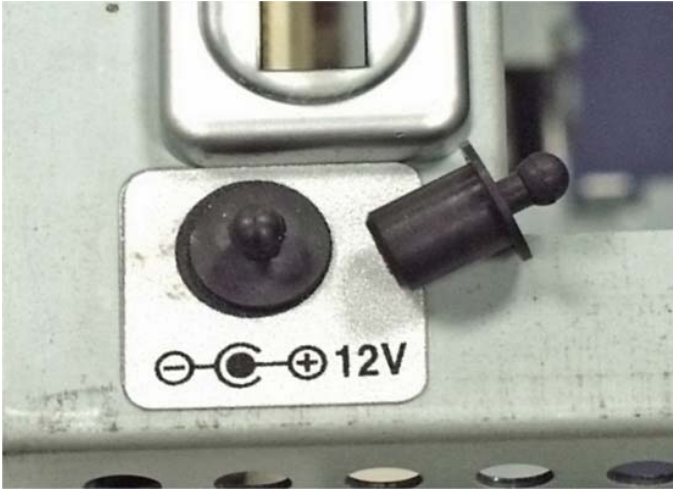

产品名称：防尘盖

规格型号：GFR-17

◆ MATERIAL: RUBBER

◆ COLOR: BLACK

◆ UNIT: mm

用途：用于电源连接器防尘与保护用。

GFR-17 结构图

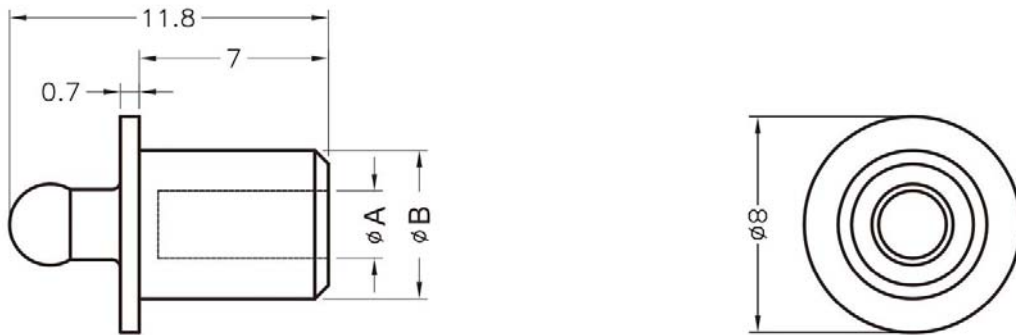

PART NO	A	B	PACKAGE
GFR-17	$\phi 4.0$	$\phi 2.0$	1000

南京诺金电气有限公司

Nanjing Nowking Electric Co., Ltd

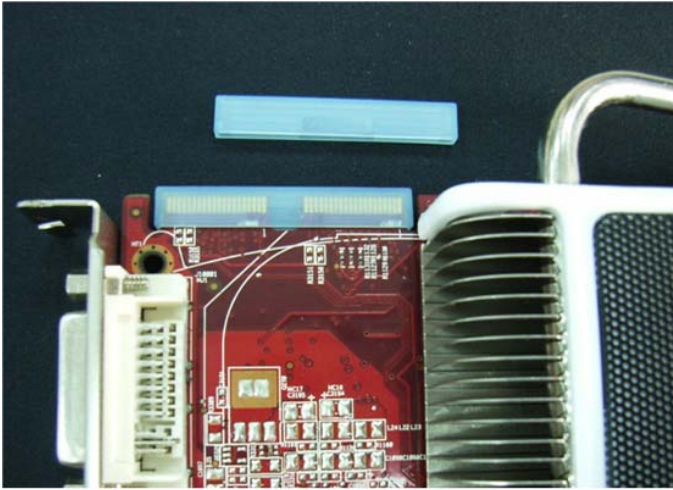

产品名称：防尘盖

规格型号：GFR-18

◆ MATERIAL: PE

◆ COLOR: TRANSPARENT, NATURAL

◆ UNIT: mm

用途：用于 PC 板金手指防尘与保护用。

GFR-18 结构图

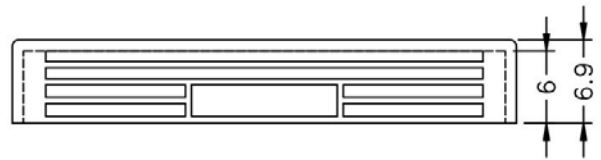
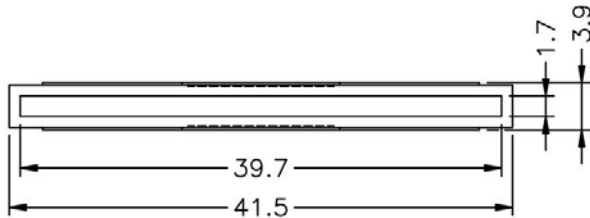

	PART NO	PACKAGE
	GFR-18	1000

南京诺金电气有限公司

Nanjing Nowking Electric Co., Ltd



产品名称：防尘盖

规格型号：GFR-19

◆ MATERIAL: PE

◆ COLOR: TRANSPARENT, NATURAL, BLUE

◆ UNIT: mm

用途：用于 PC 板金手指防尘与保护用。

GFR-19 结构图

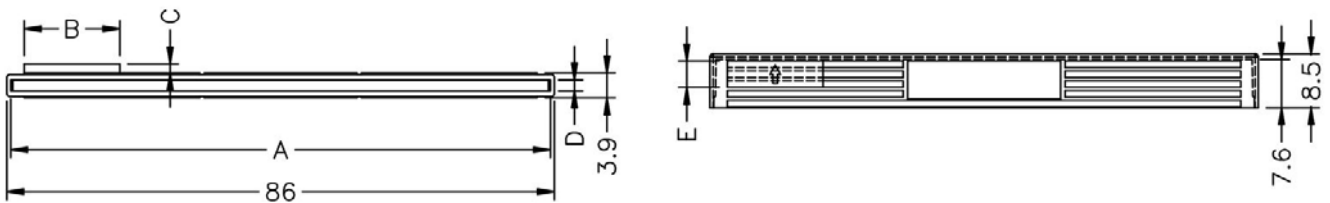

PART NO	A	B	C	D	E	PACKAGE
GFR-19	84.8	-	-	1.7	-	500

南京诺金电气有限公司

Nanjing Nowking Electric Co., Ltd

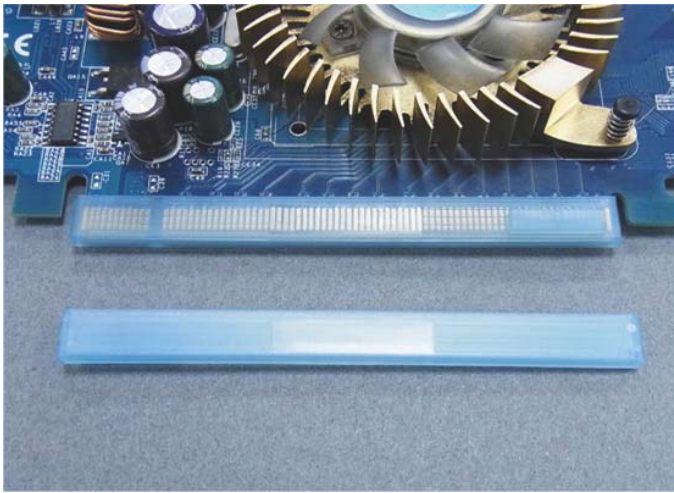

产品名称：防尘盖

规格型号：GFR-20

◆ MATERIAL: PE

◆ COLOR: TRANSPARENT, NATURAL, BLUE

◆ UNIT: mm

用途：用于 PC 板金手指防尘与保护用。

GFR-20 结构图

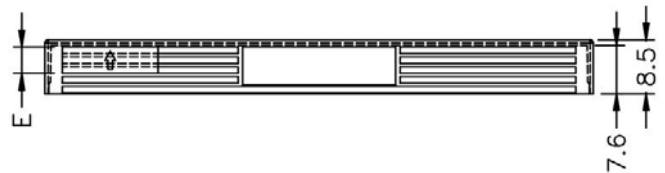
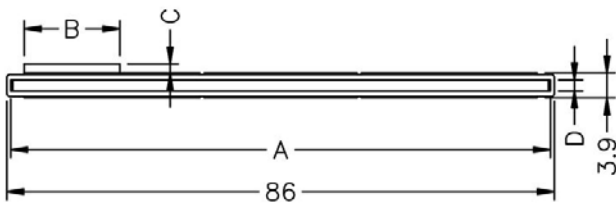

PART NO	A	B	C	D	E	PACKAGE
GFR-20	84.31	15.0	1.43	1.75	4.16	500

南京诺金电气有限公司

Nanjing Nowking Electric Co., Ltd

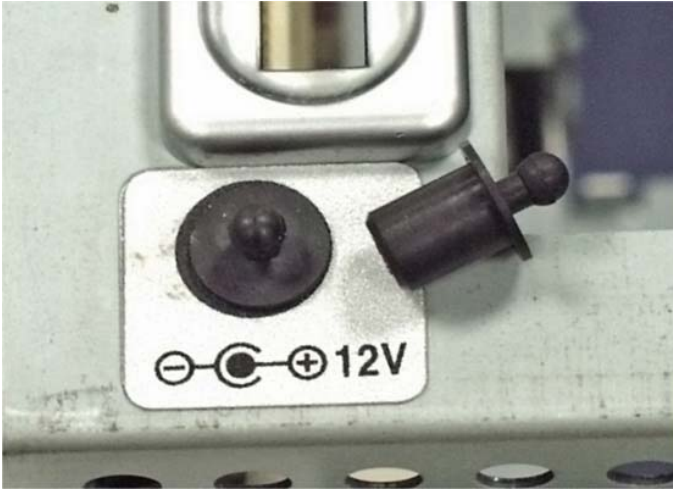

产品名称：防尘盖

规格型号：GFR-21

◆ MATERIAL: RUBBER

◆ COLOR: BLACK

◆ UNIT: mm

用途：用于电源连接器防尘与保护用。

GFR-21 结构图

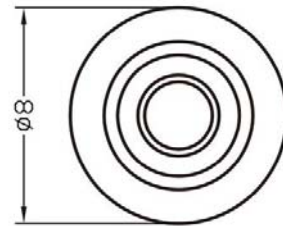
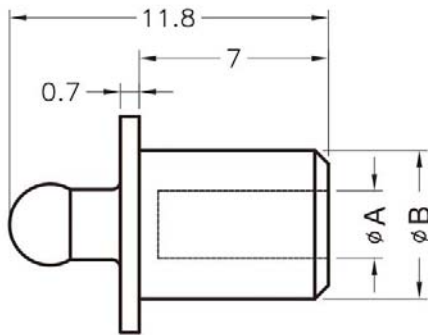

PART NO	A	B	PACKAGE
GFR-21	$\phi 5.5$	$\phi 2.5$	1000

南京诺金电气有限公司

Nanjing Nowking Electric Co., Ltd

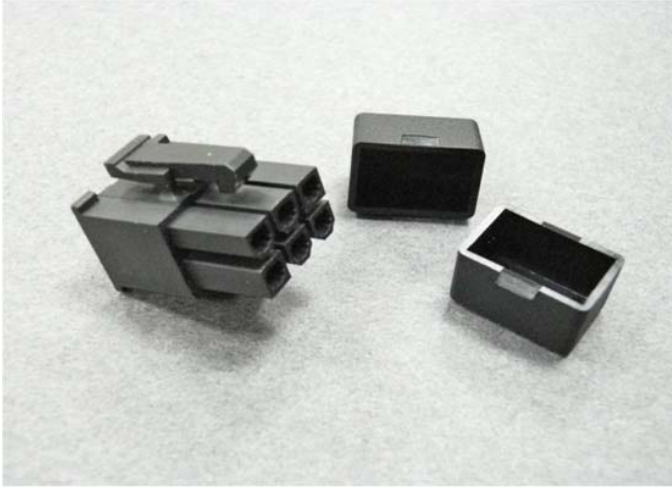

产品名称：防尘盖

规格型号：GFR-22

- ◆ MATERIAL: NYLON 66(UL)
- ◆ FLAME CLASS: 94V-0,94V-2
- ◆ COLOR:BLACK,NATURAL
- ◆ UNIT: mm

用途：用于连接器防尘与保护用。

GFR-22 结构图

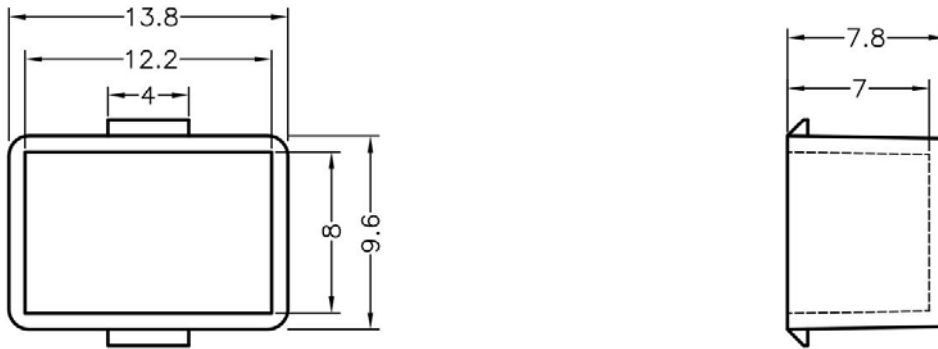

	PART NO	PACKAGE
	GFR-22	1000

南京诺金电气有限公司

Nanjing Nowking Electric Co., Ltd

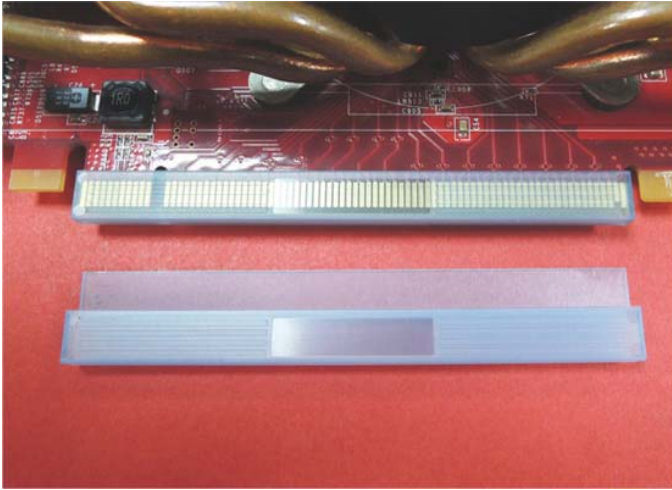

产品名称：防尘盖

规格型号：GFR-23

◆ MATERIAL: PE

◆ COLOR: TRANSPARENT, BLUE

◆ UNIT: mm

用途：用于 PC 板金手指防尘与保护用。

GFR-23 结构图

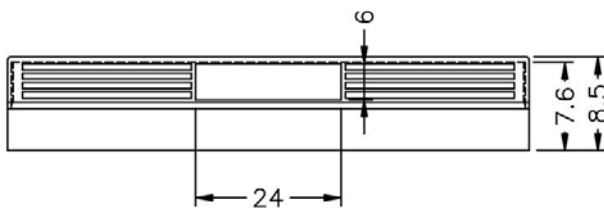
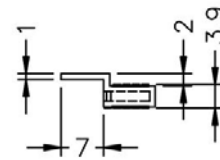
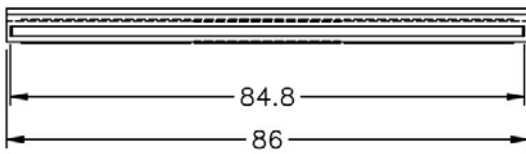

	PART NO	PACKAGE
	GFR-23	1000

南京诺金电气有限公司

Nanjing Nowking Electric Co., Ltd

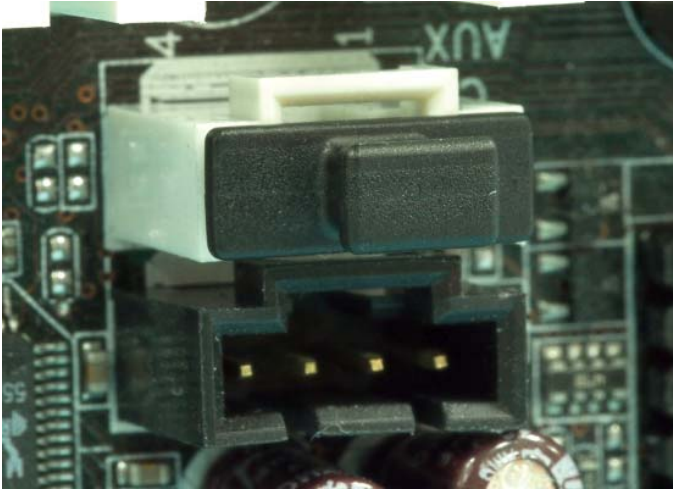

产品名称：防尘盖

规格型号：GFR-24

◆MATERIAL: PE

◆COLOR:BLACK

◆UNIT: mm

用途：用于 CD ROM 音源线防尘与保护用。

内缩为正常现象

可使用同等材质

GFR-24 结构图

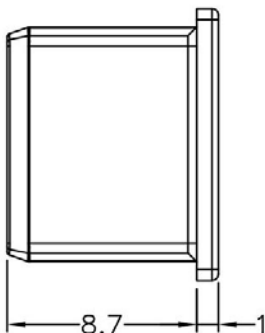
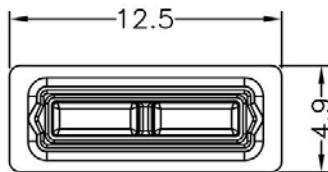

	PART NO	PACKAGE
	GFR-24	1000

南京诺金电气有限公司

Nanjing Nowking Electric Co., Ltd

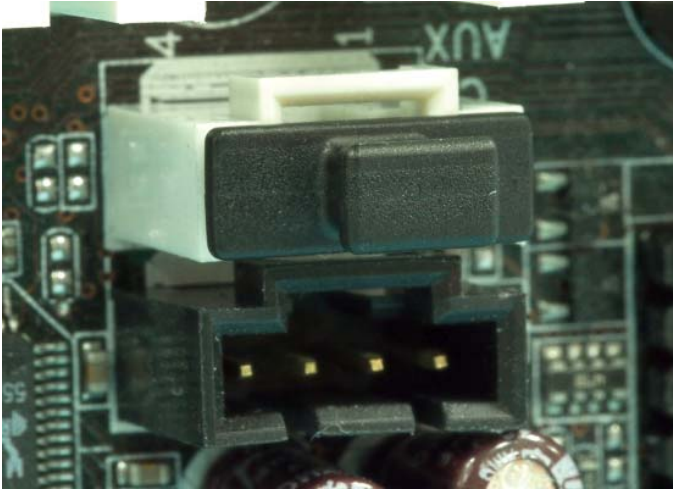

产品名称：防尘盖

规格型号：GFR-25

◆MATERIAL: PE

◆COLOR:BLACK

◆UNIT: mm

用途：用于 CD ROM 音源线防尘与保护用。

内缩为正常现象

可使用同等材质

GFR-25 结构图

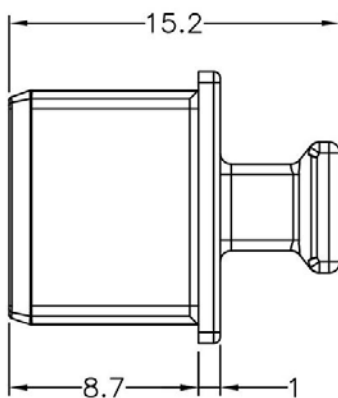
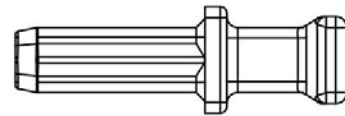
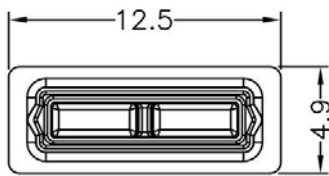

	PART NO	PACKAGE
	GFR-25	1000

南京诺金电气有限公司

Nanjing Nowking Electric Co., Ltd



产品名称：防尘盖

规格型号：GFR-26

◆ MATERIAL: PE

◆ COLOR: NATURAL

◆ UNIT: mm

用途：用于 BNC 接头防尘与保护用。

可使用同等材质

GFR-26 结构图

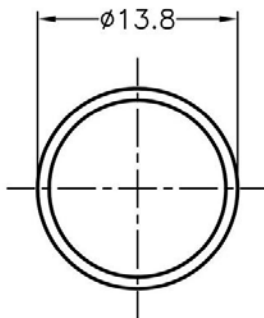
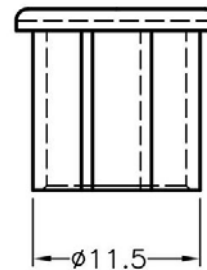
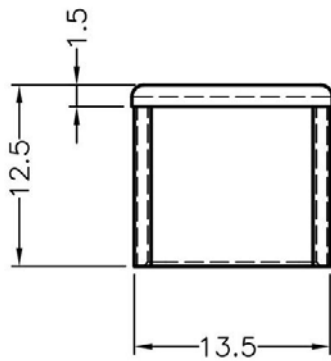

	PART NO	PACKAGE
	GFR-26	1000

南京诺金电气有限公司

Nanjing Nowking Electric Co., Ltd

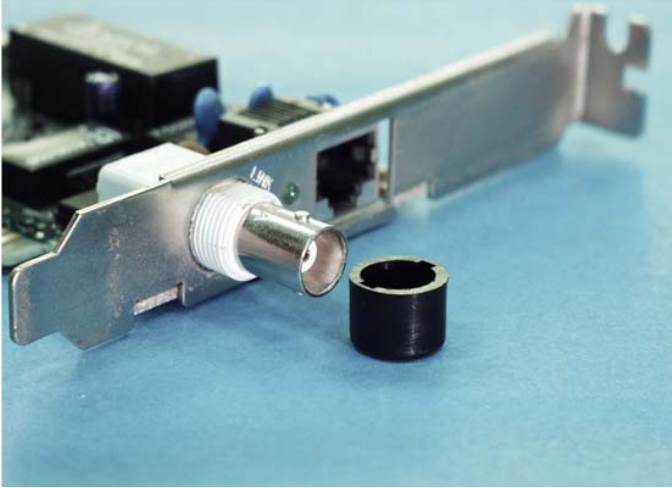

产品名称：防尘盖

规格型号：GFR-27

◆ MATERIAL: PE

◆ COLOR: BLACK, GRAY

◆ UNIT: mm

用途：用于 BNC 接头防尘与保护用。

所有尺寸量测皆不含进胶口,胶口凸出 0.3mm 之内

GFR-27 结构图

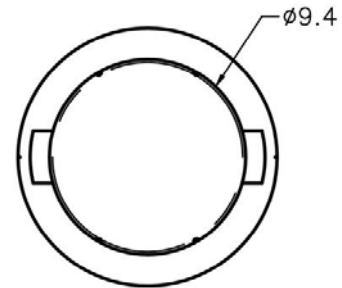
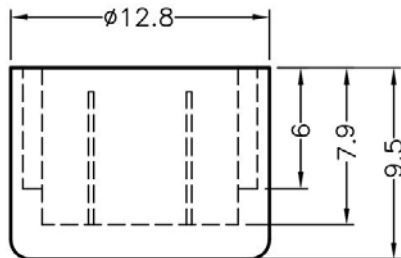

	PART NO	PACKAGE
	GFR-27	1000

南京诺金电气有限公司

Nanjing Nowking Electric Co., Ltd

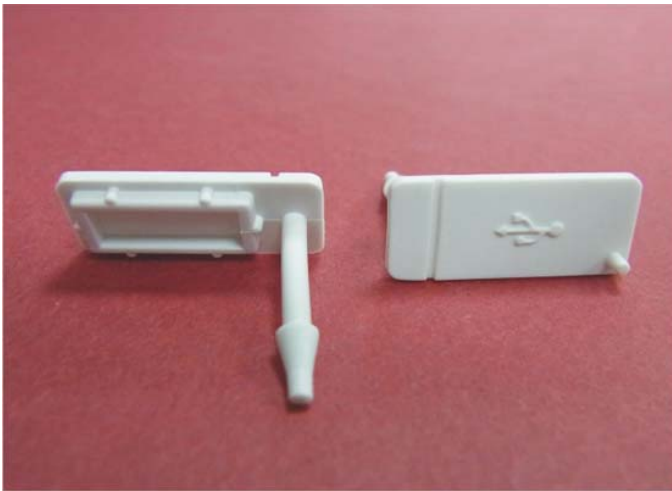

产品名称：防尘盖

规格型号：GFR-28

◆MATERIAL: TPU

◆COLOR:BLACK,WHITE

◆UNIT: mm

用途：用于 USB 防尘与保护用。

GFR-28 结构图

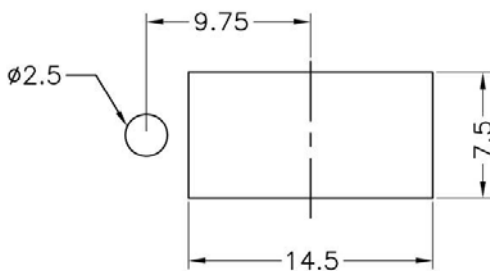
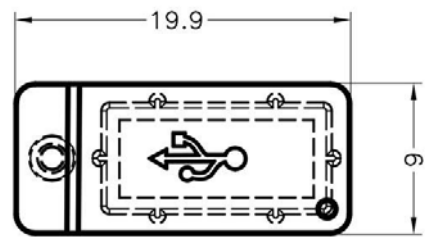
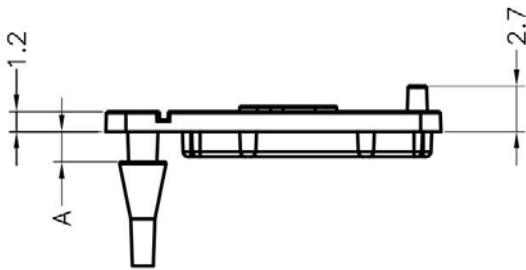

	PART NO	A	PACKAGE
	GFR-28	1.8	500

南京诺金电气有限公司

Nanjing Nowking Electric Co., Ltd

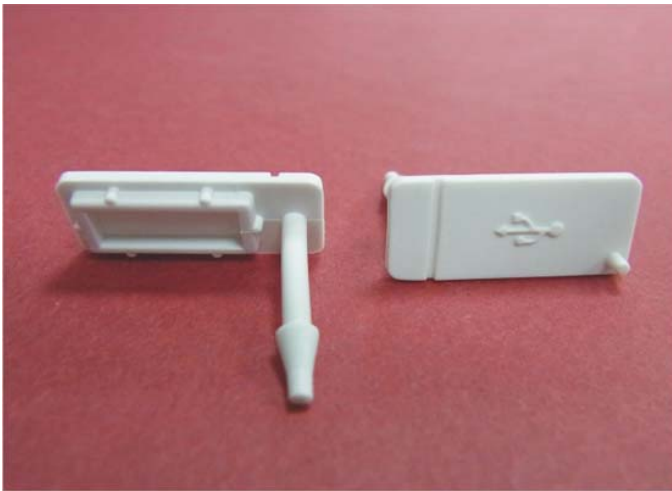

产品名称：防尘盖

规格型号：GFR-29

◆MATERIAL: TPU

◆COLOR:BLACK,WHITE

◆UNIT: mm

用途：用于 USB 防尘与保护用。

GFR-29 结构图

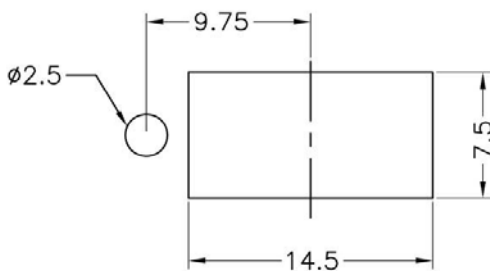
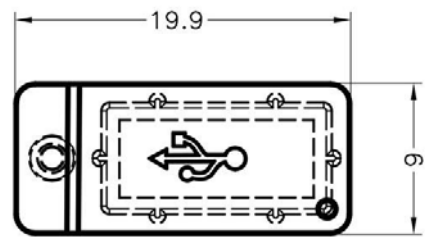
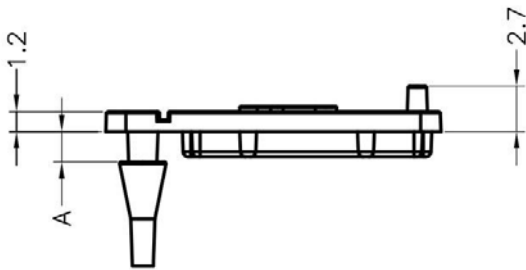

	PART NO	A	PACKAGE
	GFR-29	12.0	500

南京诺金电气有限公司

Nanjing Nowking Electric Co., Ltd



产品名称：防尘盖

规格型号：GFR-30

◆ MATERIAL: TPE

◆ COLOR: BLACK

◆ UNIT: mm

用途：用于 USB 防尘与保护用。

GFR-30 结构图

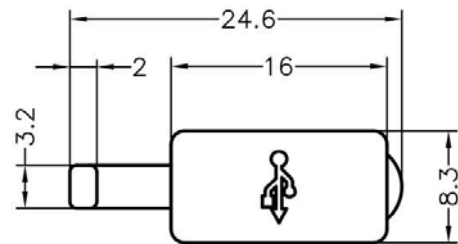
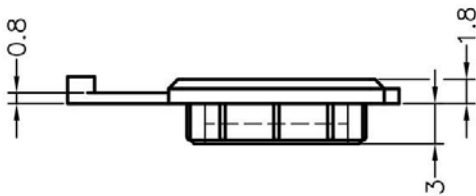

	PART NO	PACKAGE
	GFR-30	500

南京诺金电气有限公司

Nanjing Nowking Electric Co., Ltd

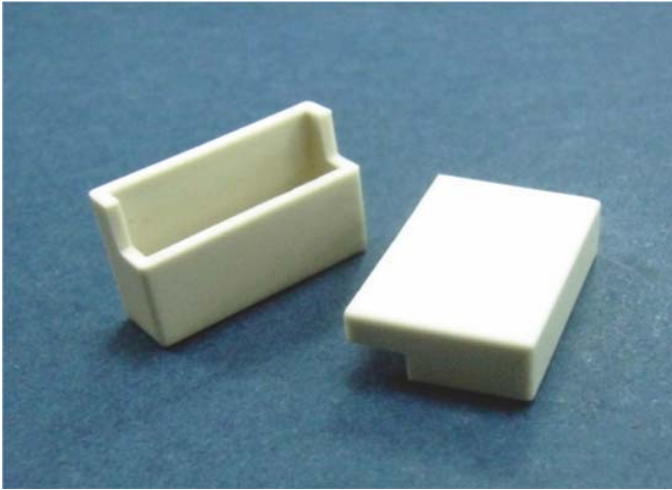

产品名称：防尘盖

规格型号：GFR-31

◆ MATERIAL: PBT(UL)

◆ FLAME CLASS: 94V-0

◆ COLOR: NATURAL

◆ UNIT: mm

用途：用于连接器防尘与保护用。

所有尺寸量测皆不含进胶口,胶口凸出 0.3mm 之内

GFR-31 结构图

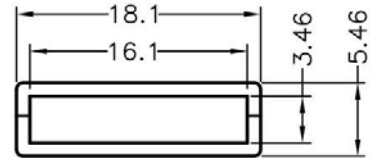
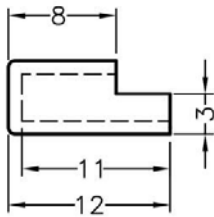

	PART NO	PACKAGE
	GFR-31	500

南京诺金电气有限公司

Nanjing Nowking Electric Co., Ltd

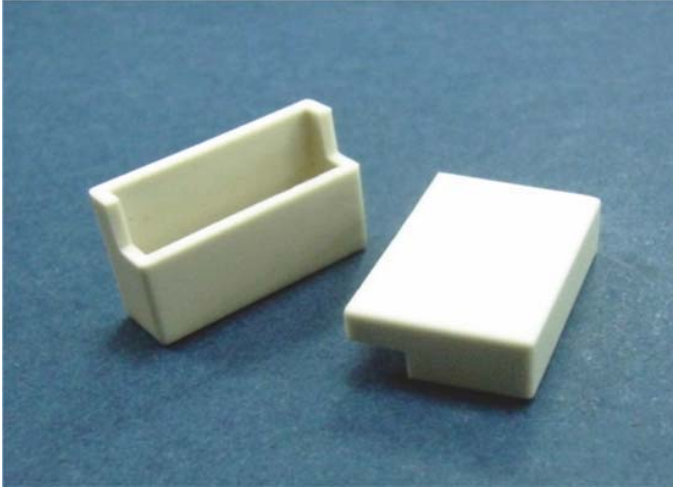

产品名称：防尘盖

规格型号：GFR-32

- ◆ MATERIAL: PBT(UL)
- ◆ FLAME CLASS: 94V-0
- ◆ COLOR: NATURAL
- ◆ UNIT: mm

用途：用于连接器防尘与保护用。

所有尺寸量测皆不含进胶口,胶口凸出 0.3mm 之内

GFR-32 结构图

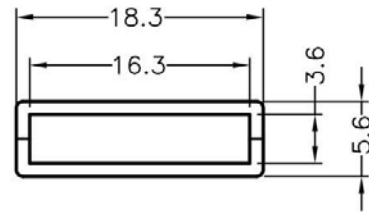
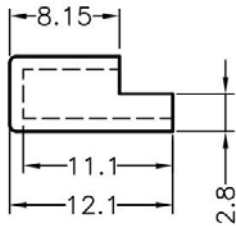

	PART NO	PACKAGE
	GFR-32	500

南京诺金电气有限公司

Nanjing Nowking Electric Co., Ltd

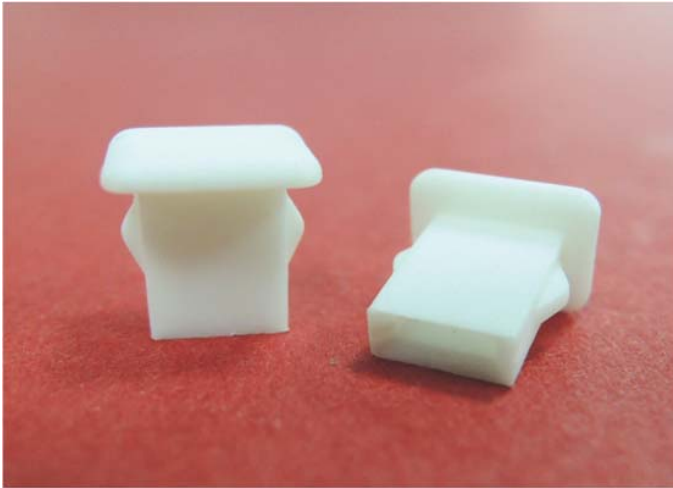

产品名称：防尘盖

规格型号：GFR-33

◆ MATERIAL: NYLON 66(UL)

◆ FLAME CLASS: 94V-0, 94V-2

◆ COLOR: NATURAL, BLACK

◆ UNIT: mm

用途：用于防尘与保护用。

所有尺寸量测皆不含进胶口,胶口凸出 0.3mm 之内

GFR-33 结构图

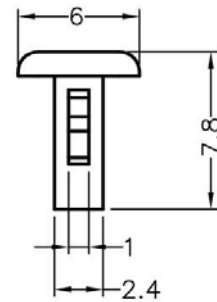
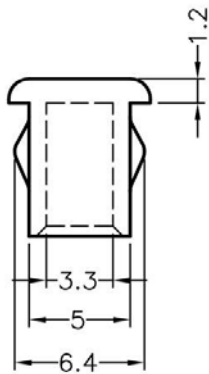

	PART NO	PACKAGE
	GFR-33	1000

南京诺金电气有限公司

Nanjing Nowking Electric Co., Ltd



产品名称：防尘盖

规格型号：GFR-34

◆ MATERIAL: PE

◆ COLOR: BLACK

◆ UNIT: mm

用途：用于汽车，连接器防尘与保护用。

GFR-34 结构图

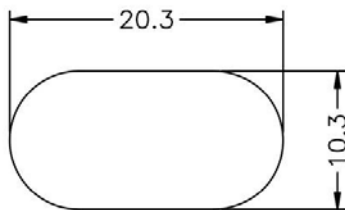
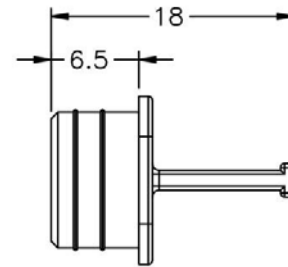
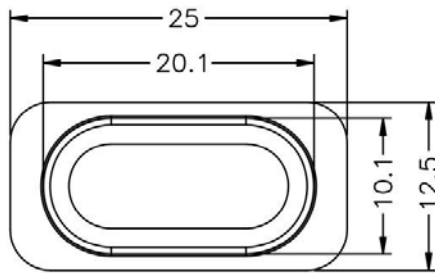

MOUNTING HOLE

	PART NO	PACKAGE
	GFR-34	1000

南京诺金电气有限公司

Nanjing Nowking Electric Co., Ltd



产品名称：防尘盖

规格型号：GFR-35

◆ MATERIAL: ABS(UL)

◆ FLAME CLASS:94HB

◆ COLOR:BLACK

◆ UNIT: mm

用途：用于连接器防尘与保护用。

GFR-35 结构图

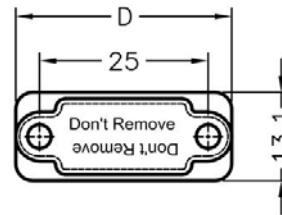
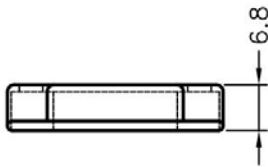

PART NO	D	PACKAGE
GFR-35	34.0	1000

南京诺金电气有限公司

Nanjing Nowking Electric Co., Ltd



产品名称：防尘盖

规格型号：GFR-36

◆ MATERIAL: ABS(UL)

◆ FLAME CLASS:94HB

◆ COLOR:BLACK

◆ UNIT: mm

用途：用于连接器防尘与保护用。

GFR-36 结构图

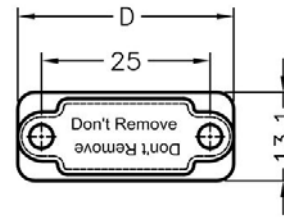
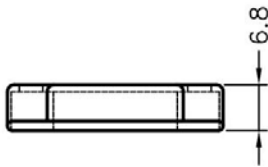

	PART NO	D	PACKAGE
	GFR-36	32.0	1000

南京诺金电气有限公司

Nanjing Nowking Electric Co., Ltd

产品名称：防尘盖

规格型号：GFR-37

◆ MATERIAL: ABS(UL)

◆ FLAME CLASS:94HB

◆ COLOR:BLACK

◆ UNIT: mm

用途：用于防尘与保护用。



GFR-37 结构图

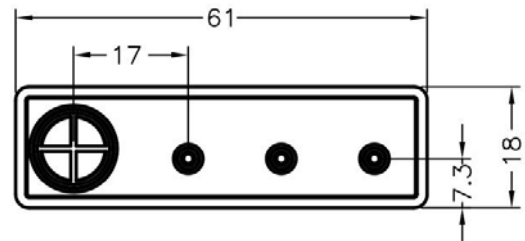

	PART NO	PACKAGE
	GFR-37	500

南京诺金电气有限公司

Nanjing Nowking Electric Co., Ltd



产品名称：防尘盖

规格型号：GFR-38

◆ MATERIAL: TPE

◆ COLOR: BLACK

◆ UNIT: mm

用途：用于汽车点烟器防尘与保护用。

GFR-38 结构图

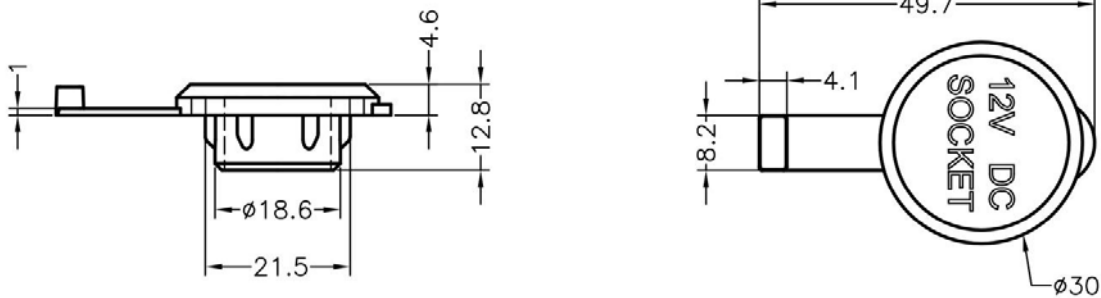

	PART NO	PACKAGE
	GFR-38	500

南京诺金电气有限公司

Nanjing Nowking Electric Co., Ltd

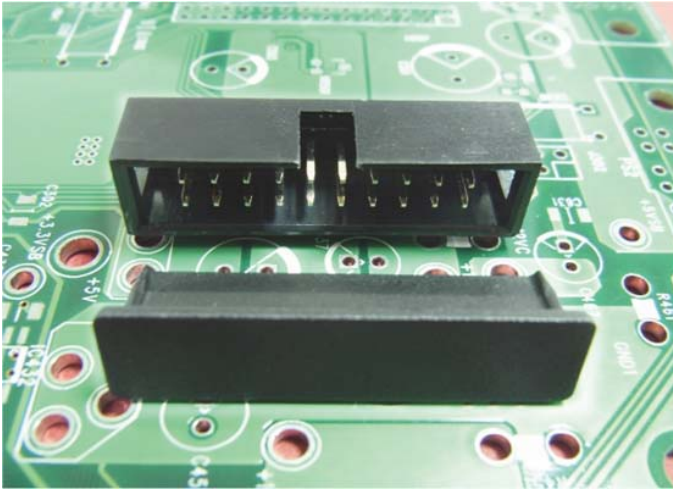

产品名称：防尘盖

规格型号：GFR-39

◆ MATERIAL: PE

◆ COLOR: BLACK

◆ UNIT: mm

用途：用于 IDE CONNECTOR 防尘与保护用。

所有尺寸量测皆不含进胶口,胶口凸出 0.3mm 之内

GFR-39 结构图

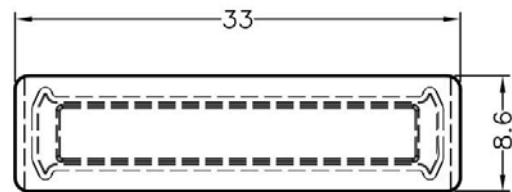
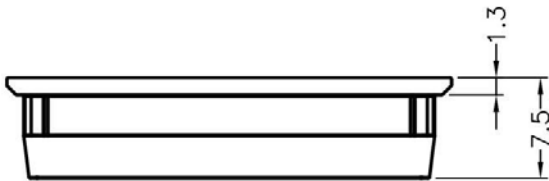

	PART NO	PACKAGE
	GFR-39	500

南京诺金电气有限公司

Nanjing Nowking Electric Co., Ltd

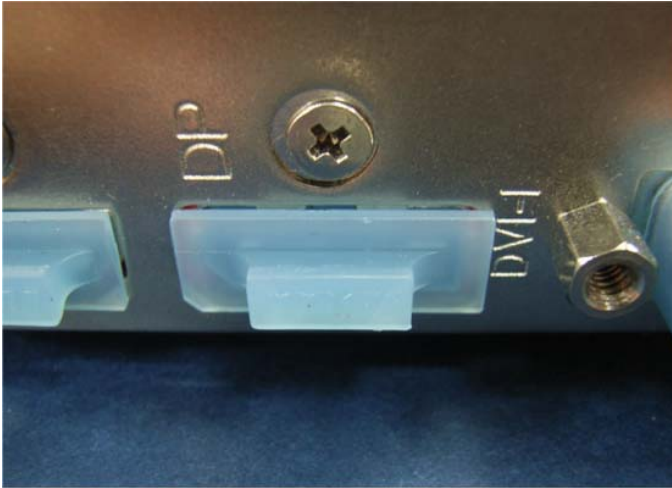

产品名称：防尘盖

规格型号：GFR-40

◆ MATERIAL: PE

◆ COLOR: NATURAL, TRANSPARENT, BLUE

◆ UNIT: mm

用途：用于数码 D.P 端子防尘与保护用。

所有尺寸量测皆不含进胶口,胶口凸出 0.3mm 之内

GFR-40 结构图

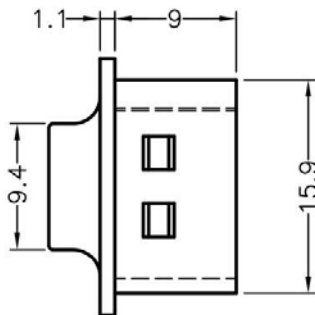
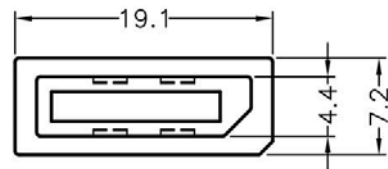
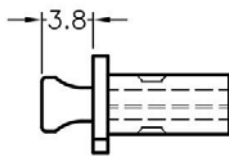

	PART NO	PACKAGE
	GFR-40	1000

南京诺金电气有限公司

Nanjing Nowking Electric Co., Ltd



产品名称：防尘盖

规格型号：GFR-41

◆ MATERIAL: PE

◆ COLOR: BLACK

◆ UNIT: mm

用途：用于数码 D.P 端子防尘与保护用。

所有尺寸量测皆不含进胶口,胶口凸出 0.3mm 之内

GFR-41 结构图

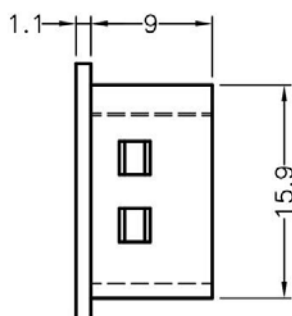
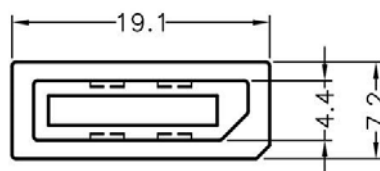
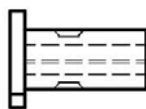

	PART NO	PACKAGE
	GFR-41	1000

南京诺金电气有限公司

Nanjing Nowking Electric Co., Ltd

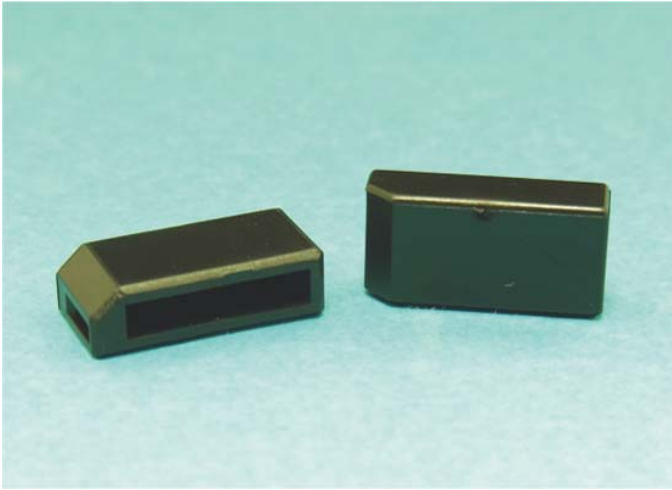

产品名称：防尘盖

规格型号：GFR-42

◆MATERIAL: PE

◆COLOR:BLACK

◆UNIT: mm

用途：使多余或无功能的 Display Port (DP 端子)遮蔽,避免使用者误插。

所有尺寸量测皆不含进胶口,胶口凸出 0.3mm 之内

GFR-42 结构图

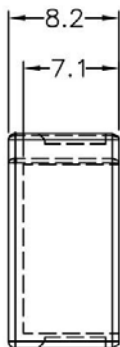
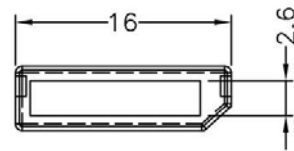

	PART NO	PACKAGE
	GFR-42	1000

南京诺金电气有限公司

Nanjing Nowking Electric Co., Ltd

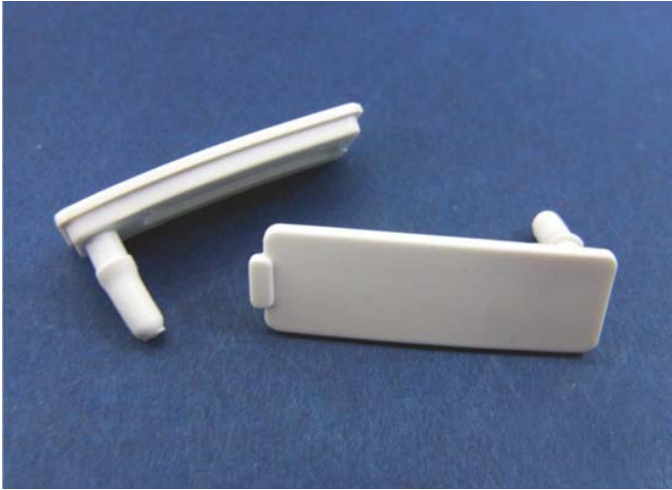

产品名称：防尘盖

规格型号：GFR-43

◆ MATERIAL: TPU

◆ COLOR: BLACK, WHITE

◆ UNIT: mm

用途：用于 SIM CARD CAP 防尘与保护用。

GFR-43 结构图

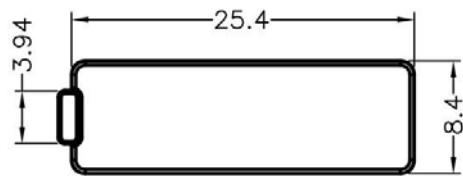
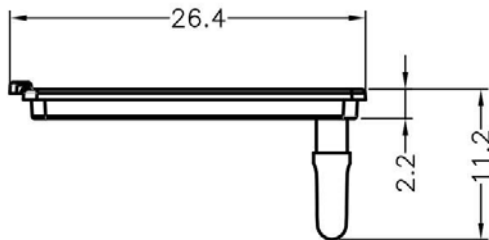

	PART NO	PACKAGE
	GFR-43	500

南京诺金电气有限公司

Nanjing Nowking Electric Co., Ltd



产品名称：防尘盖

规格型号：GFR-44

◆ MATERIAL: PE

◆ COLOR: BLACK, WHITE

◆ UNIT: mm

用途：用于连接器防尘与保护用。

可使用同等材质

GFR-44 结构图

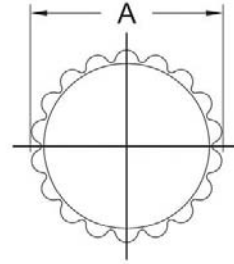
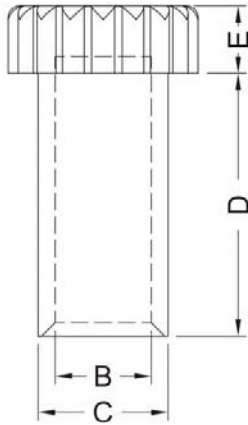

PART NO	A	B	C	D	E	PACKAGE
GFR-44	5.7	2.85	3.85	7.8	2.0	1000

南京诺金电气有限公司

Nanjing Nowking Electric Co., Ltd



产品名称：防尘盖

规格型号：GFR-45

◆ MATERIAL: PE

◆ COLOR: NATURAL

◆ UNIT: mm

用途：用于连接器防尘与保护使用。

所有尺寸量测皆不含进胶口,胶口凸出 0.3mm 之内

GFR-45 结构图

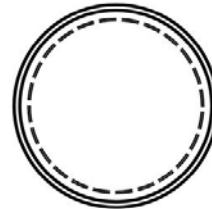
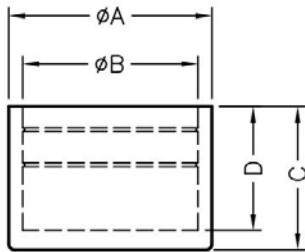

PART NO	A	B	C	D	PACKAGE
GFR-45	15.8	13.4	11.2	10.0	500

南京诺金电气有限公司

Nanjing Nowking Electric Co., Ltd



产品名称：防尘盖

规格型号：GFR-46

◆ MATERIAL: PE

◆ COLOR: NATURAL

◆ UNIT: mm

用途：用于连接器防尘与保护使用。

所有尺寸量测皆不含进胶口,胶口凸出 0.3mm 之内

GFR-46 结构图

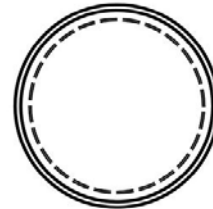
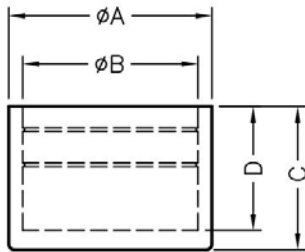

PART NO	A	B	C	D	PACKAGE
GFR-46	10.7	9.0	9.6	8.6	1000

南京诺金电气有限公司

Nanjing Nowking Electric Co., Ltd



产品名称：防尘盖

规格型号：GFR-47

◆ MATERIAL: PE

◆ COLOR: NATURAL

◆ UNIT: mm

用途：用于连接器防尘与保护使用。

所有尺寸量测皆不含进胶口,胶口凸出 0.3mm 之内

GFR-47 结构图

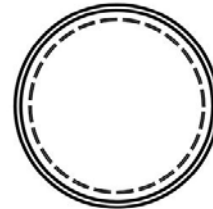
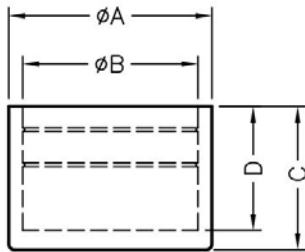

PART NO	A	B	C	D	PACKAGE
GFR-47	10.3	8.4	8.0	7.0	1000

南京诺金电气有限公司

Nanjing Nowking Electric Co., Ltd



产品名称：防尘盖

规格型号：GFR-48

◆ MATERIAL: PE

◆ COLOR: BLACK, RED

◆ UNIT: mm

用途：用于连接器防尘与保护使用。

所有尺寸量测皆不含进胶口,胶口凸出 0.3mm 之内

GFR-48 结构图

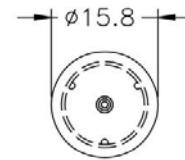
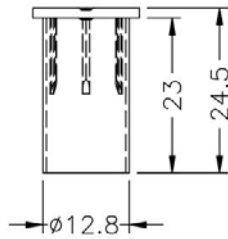

	PART NO	PACKAGE
	GFR-48	1000

南京诺金电气有限公司

Nanjing Nowking Electric Co., Ltd



产品名称：防尘盖

规格型号：GFR-49

◆ MATERIAL: PE

◆ COLOR: BLACK, NATURAL

◆ UNIT: mm

用途：用于连接器防尘与保护使用。

所有尺寸量测皆不含进胶口,胶口凸出 0.3mm 之内

GFR-49 结构图

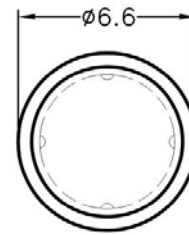
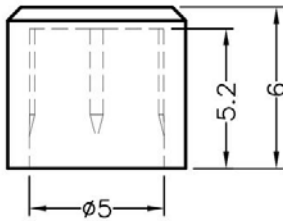

	PART NO	PACKAGE
	GFR-49	1000

南京诺金电气有限公司

Nanjing Nowking Electric Co., Ltd



产品名称：防尘盖

规格型号：GFR-50

- ◆ MATERIAL: PP(UL)
- ◆ FLAME CALSS: 94HB
- ◆ COLOR:BLACK
- ◆ UNIT: mm

用途：用于连接器防尘与保护使用。

所有尺寸量测皆不含进胶口,胶口凸出 0.3mm 之内

GFR-50 结构图

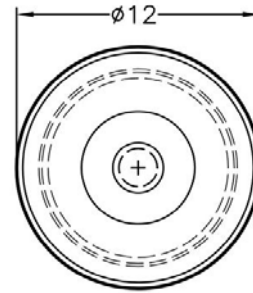
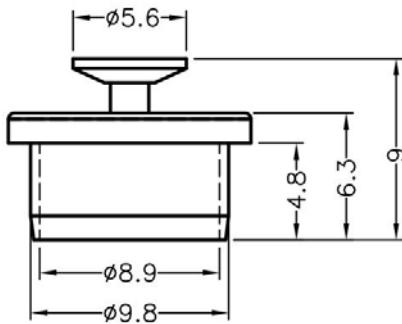

	PART NO	PACKAGE
	GFR-50	1000

南京诺金电气有限公司

Nanjing Nowking Electric Co., Ltd



产品名称：防尘盖

规格型号：GFR-51

◆ MATERIAL: PE

◆ COLOR: NATURAL

◆ UNIT: mm

用途：用于 USB 接头防尘与保护使用。

所有尺寸量测皆不含进胶口,胶口凸出 0.3mm 之内

GFR-51 结构图

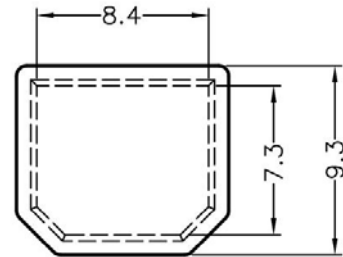
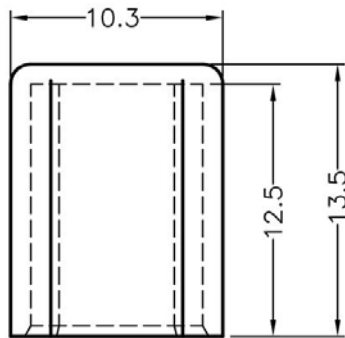

	PART NO	PACKAGE
	GFR-51	1000

南京诺金电气有限公司

Nanjing Nowking Electric Co., Ltd

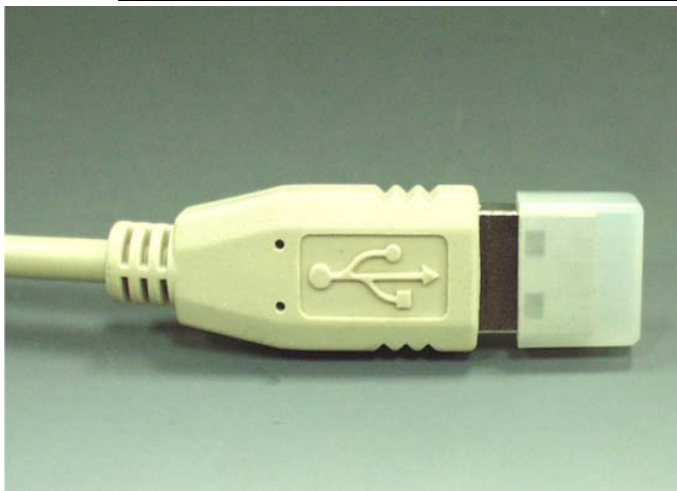

产品名称：防尘盖

规格型号：GFR-52

◆ MATERIAL: PE

◆ COLOR: NATURAL

◆ UNIT: mm

用途：用于 USB 接头防尘与保护使用。

所有尺寸量测皆不含进胶口,胶口凸出 0.3mm 之内

GFR-52 结构图

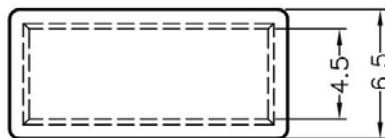
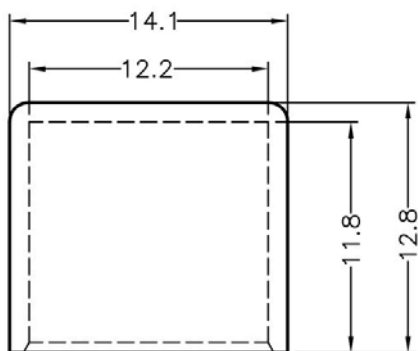

	PART NO	PACKAGE
	GFR-52	1000

南京诺金电气有限公司

Nanjing Nowking Electric Co., Ltd

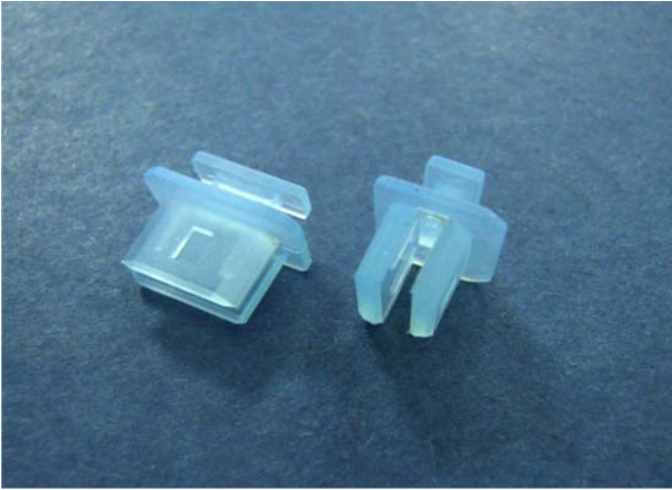

产品名称：防尘盖

规格型号：GFR-53

◆ MATERIAL: PE

◆ COLOR: NATURAL, BLUE, TRANSPARENT

◆ UNIT: mm

用途：用于 MINI 数码端子防尘盖。

所有尺寸量测皆不含进胶口,胶口凸出 0.3mm 之内

GFR-53 结构图

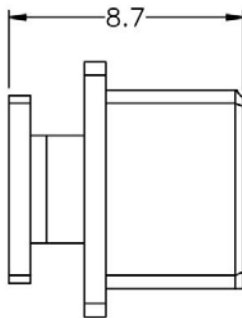
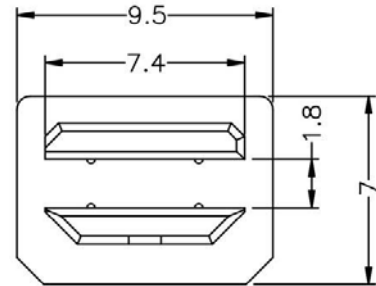
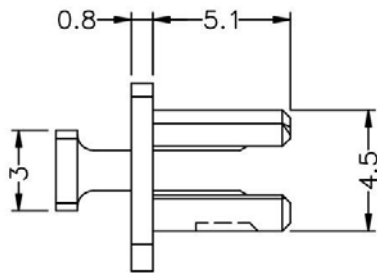

	PART NO	PACKAGE
	GFR-53	2000

南京诺金电气有限公司

Nanjing Nowking Electric Co., Ltd

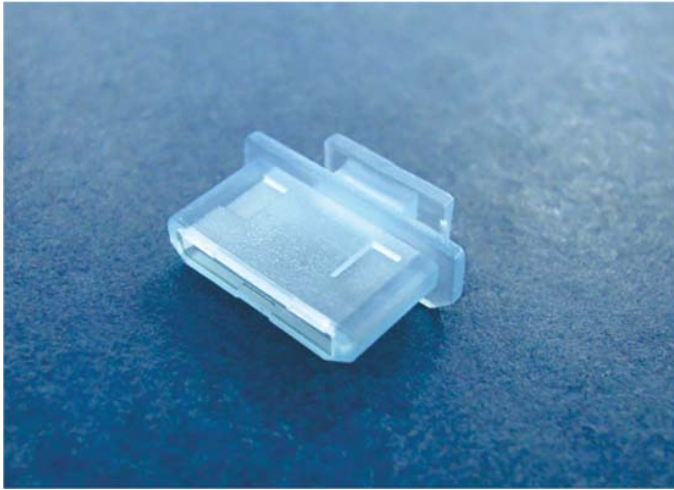

产品名称：防尘盖

规格型号：GFR-54

◆ MATERIAL: PE

◆ COLOR: NATURAL, BLUE, TRANSPARENT

◆ UNIT: mm

用途：用于 MINI 数码端子防尘盖。

所有尺寸量测皆不含进胶口,胶口凸出 0.3mm 之内

GFR-54 结构图

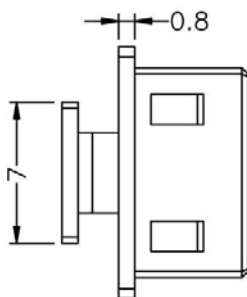
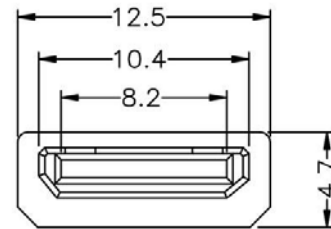
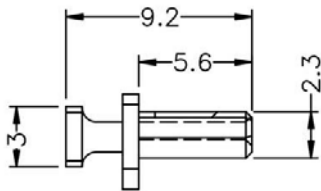

	PART NO	PACKAGE
	GFR-54	2000

南京诺金电气有限公司

Nanjing Nowking Electric Co., Ltd



产品名称：防尘盖

规格型号：GFR-55

◆ MATERIAL: PE

◆ COLOR: NATURAL, BLUE, TRANSPARENT

◆ UNIT: mm

用途：用于 MINI 数码端子防尘盖。

所有尺寸量测皆不含进胶口,胶口凸出 0.3mm 之内

GFR-55 结构图

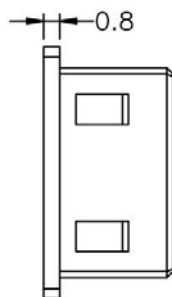
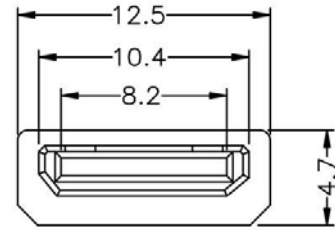
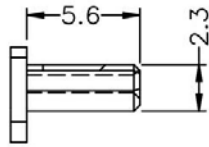

	PART NO	PACKAGE
	GFR-55	2000

南京诺金电气有限公司

Nanjing Nowking Electric Co., Ltd



产品名称：防尘盖

规格型号：GFR-56

- ◆ MATERIAL: NYLON 66(UL)
- ◆ FLAME CLASS: 94V-0,94V-2
- ◆ COLOR:NATURAL,BLACK
- ◆ UNIT: mm

用途：用于防尘盖与保护。

GFR-56 结构图

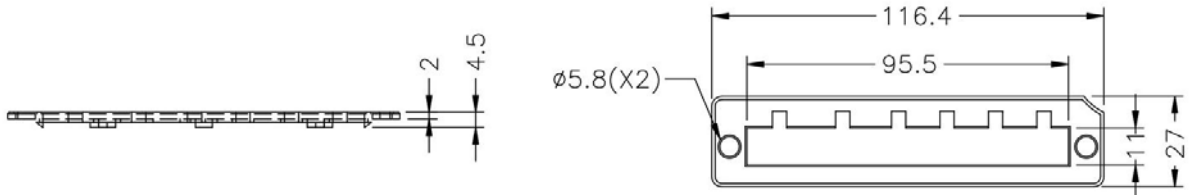

	PART NO	PACKAGE
	GFR-56	500

南京诺金电气有限公司

Nanjing Nowking Electric Co., Ltd



产品名称：防尘盖

规格型号：GFR-57

- ◆ MATERIAL: NYLON 66(UL)
- ◆ FLAME CLASS: 94V-0,94V-2
- ◆ COLOR:NATURAL,BLACK
- ◆ UNIT: mm

用途：用于防尘与保护。

所有尺寸量测皆不含进胶口,胶口凸出 0.3mm 之内

GFR-57 结构图

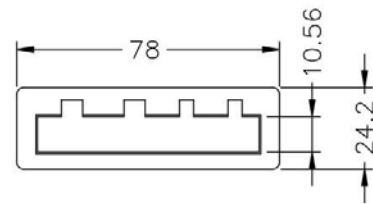

	PART NO	PACKAGE
	GFR-57	500

南京诺金电气有限公司

Nanjing Nowking Electric Co., Ltd



产品名称：防尘盖

规格型号：GFR-58

- ◆ MATERIAL: NYLON 66(UL)
- ◆ FLAME CLASS: 94V-0,94V-2
- ◆ COLOR:NATURAL,BLACK
- ◆ UNIT: mm

用途：用于防尘与保护。

所有尺寸量测皆不含进胶口,胶口凸出 0.3mm 之内

GFR-58 结构图

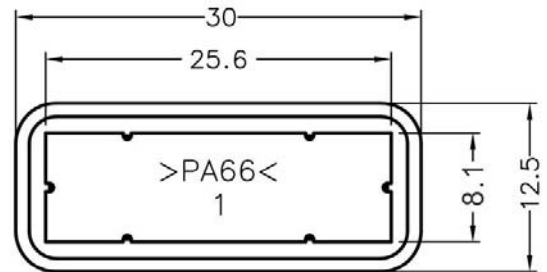

	PART NO	PACKAGE
	GFR-58	500

南京诺金电气有限公司

Nanjing Nowking Electric Co., Ltd

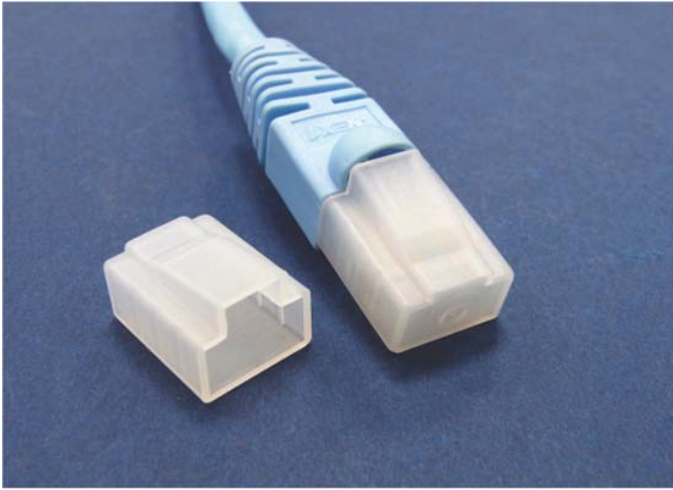

产品名称：防尘盖

规格型号：GFR-59

◆ MATERIAL: PE

◆ COLOR: NATURAL

◆ UNIT: mm

用途：用于 RJ-45 连接器防尘与保护。

所有尺寸量测皆不含进胶口,胶口凸出 0.3mm 之内

GFR-59 结构图

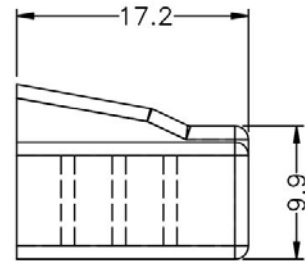
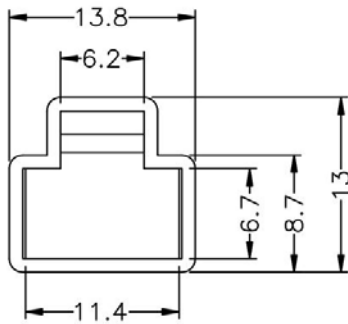

	PART NO	PACKAGE
	GFR-59	1000

南京诺金电气有限公司

Nanjing Nowking Electric Co., Ltd



产品名称：防尘盖

规格型号：GFR-60

◆ MATERIAL: PVC

◆ COLOR: BLACK

◆ UNIT: mm

用途：用于网络接头防尘与锁定。

所有尺寸量测皆不含进胶口,胶口凸出 0.3mm 之内

GFR-60 结构图

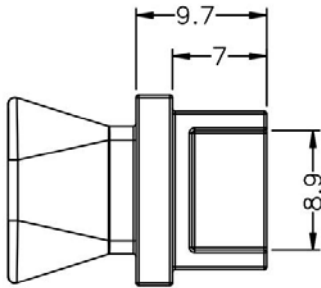
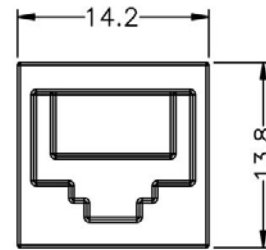
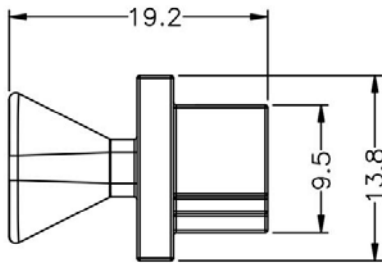

	PART NO	PACKAGE
	GFR-60	500

南京诺金电气有限公司

Nanjing Nowking Electric Co., Ltd



产品名称：防尘盖

规格型号：GFR-61

◆ MATERIAL: SILICON RUBBER(UL)

◆ FLAME CLASS: 94V-0

◆ COLOR:BLACK

◆ UNIT: mm

用途：用于 USB 防尘与保护。

可使用同等材质

GFR-61 结构图

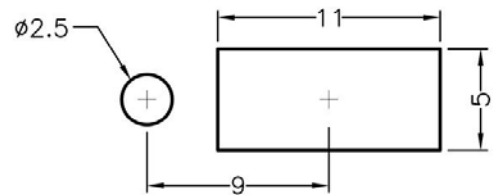
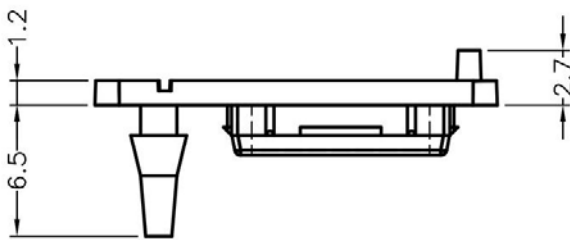

MOUNTING HOLES
CHASSIS THICKNESS 1.0 mm

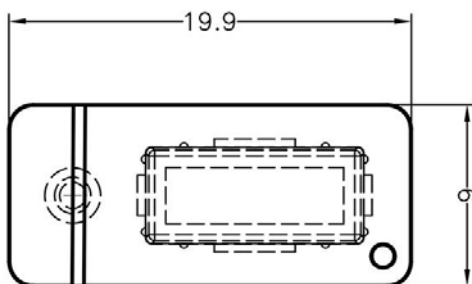

	PART NO	PACKAGE
	GFR-61	1000

南京诺金电气有限公司

Nanjing Nowking Electric Co., Ltd

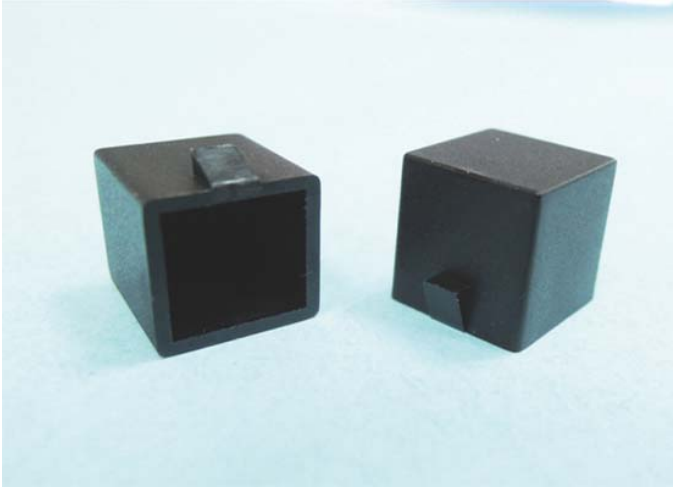

产品名称：防尘盖

规格型号：GFR-62

- ◆ MATERIAL: NYLON 66(UL)
- ◆ FLAME CLASS: 94V-0,94V-2
- ◆ COLOR:BLACK,NATURAL
- ◆ UNIT: mm

用途：用于连接器防尘与保护。

GFR-62 结构图

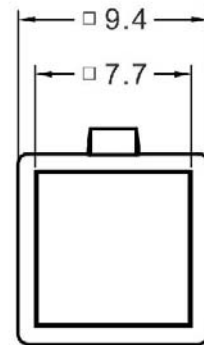
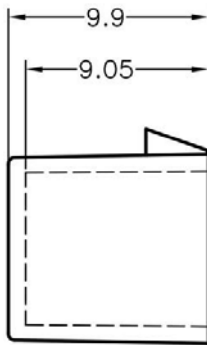

	PART NO	PACKAGE
	GFR-62	1000

南京诺金电气有限公司

Nanjing Nowking Electric Co., Ltd

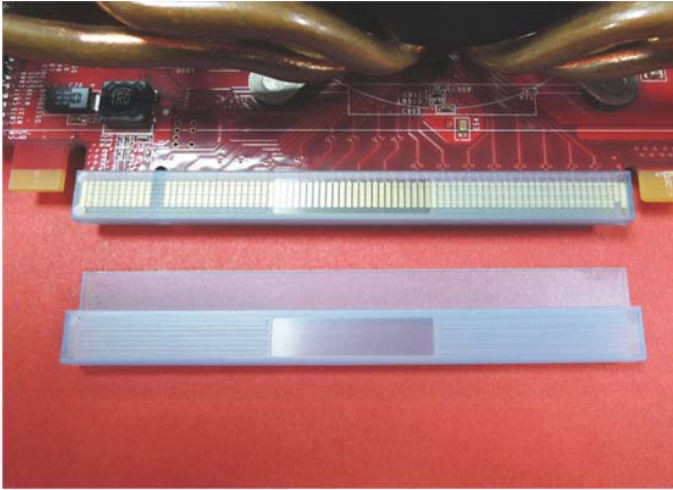

产品名称：防尘盖

规格型号：GFR-63

◆ MATERIAL: PE

◆ COLOR: TRANSPARENT BLUE

◆ UNIT: mm

用途：用于 PC 板金手指防尘与保护。

GFR-63 结构图

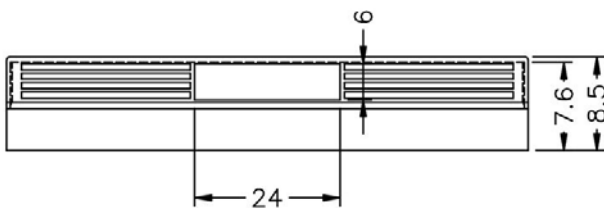
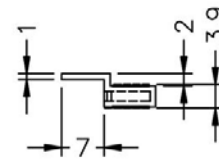
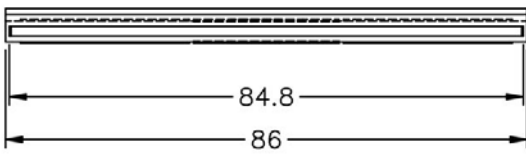

	PART NO	PACKAGE
	GFR-63	1000

南京诺金电气有限公司

Nanjing Nowking Electric Co., Ltd



产品名称：防尘盖

规格型号：GFR-64

◆ MATERIAL: PE

◆ COLOR: NATURAL

◆ UNIT: mm

用途：用于 MINI USB 接头防尘与保护。

所有尺寸量测皆不含进胶口,胶口凸出 0.3mm 之内

GFR-64 结构图

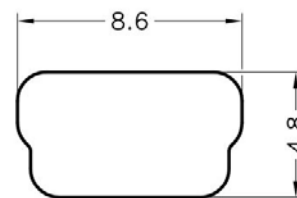
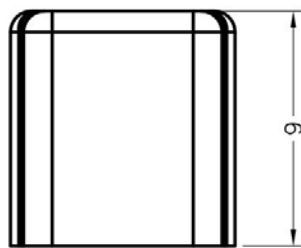

	PART NO	PACKAGE
	GFR-64	500

南京诺金电气有限公司

Nanjing Nowking Electric Co., Ltd



产品名称：防尘盖

规格型号：GFR-65

◆ MATERIAL: PE

◆ COLOR: NATURAL

◆ UNIT: mm

用途：用于 MINI USB 接头防尘与保护。

所有尺寸量测皆不含进胶口,胶口凸出 0.3mm 之内

GFR-65 结构图

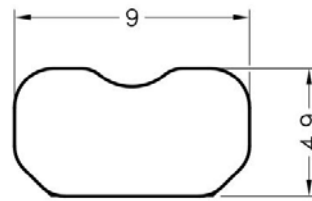
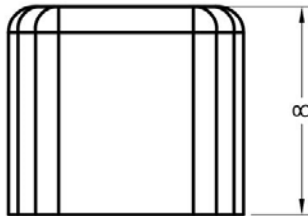

	PART NO	PACKAGE
	GFR-65	2000

南京诺金电气有限公司

Nanjing Nowking Electric Co., Ltd

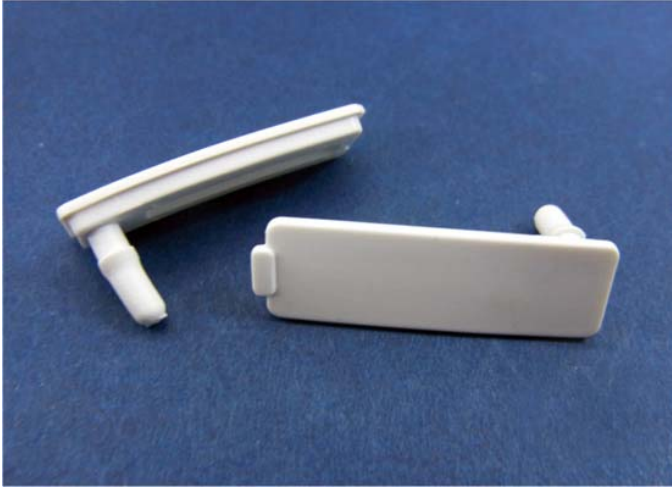

产品名称：防尘盖

规格型号：GFR-66

◆ MATERIAL: TPU

◆ COLOR: BLAKC, WHITE

◆ UNIT: mm

用途：用于 SIM CARD CAP 接头防尘与保护。

内缩为正常现象

可使用同等材质

GFR-66 结构图

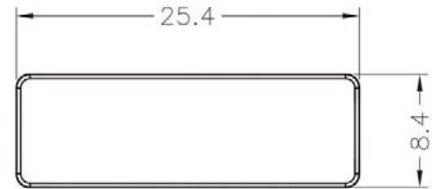
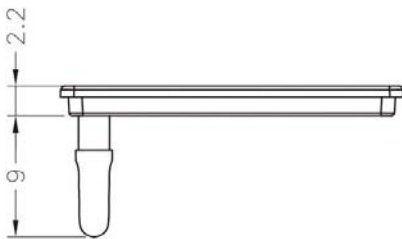

	PART NO	PACKAGE
	GFR-66	500

南京诺金电气有限公司

Nanjing Nowking Electric Co., Ltd

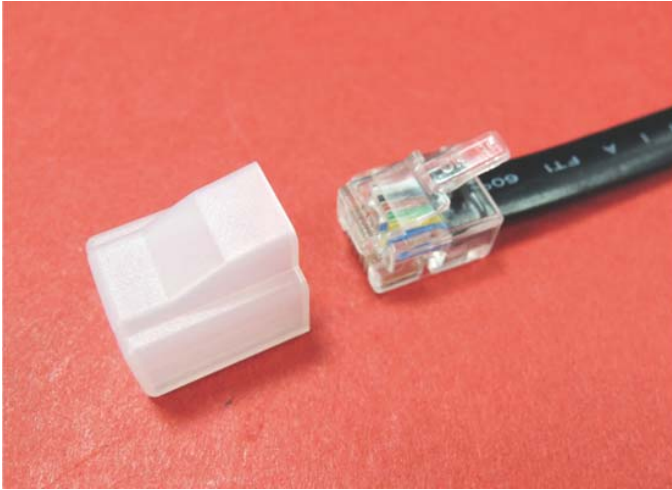

产品名称：防尘盖

规格型号：GFR-67

◆ MATERIAL: PE

◆ COLOR: NATRUAL

◆ UNIT: mm

用途：用于 RJ11 接头防尘与保护。

GFR-67 结构图

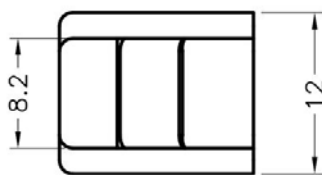
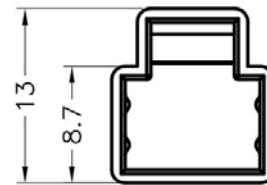
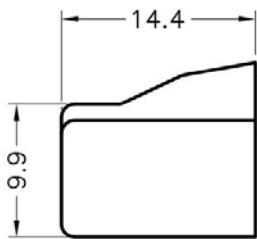

	PART NO	PACKAGE
	GFR-67	1000

南京诺金电气有限公司

Nanjing Nowking Electric Co., Ltd

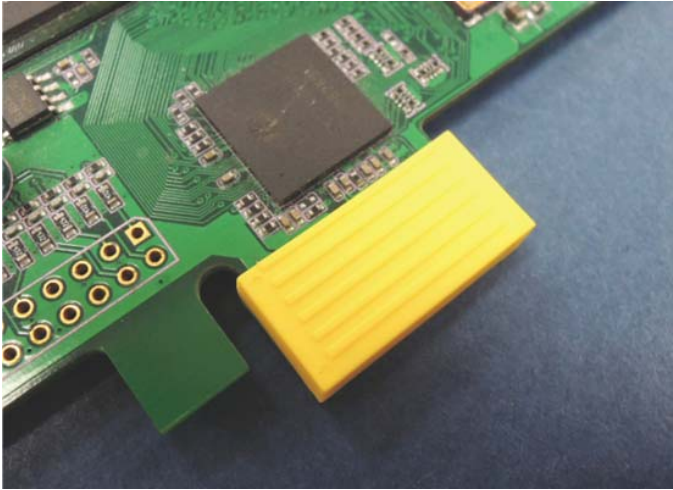

产品名称：防尘盖

规格型号：GFR-67

◆ MATERIAL: PE

◆ COLOR: YELLOW

◆ UNIT: mm

用途：用于 PC 板金手指接头防尘与保护。

GFR-67 结构图

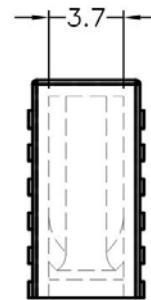
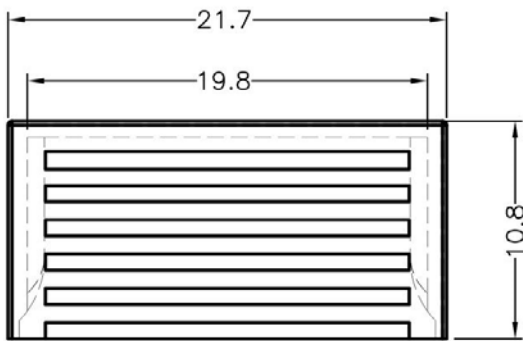

	PART NO	PACKAGE
	GFR-67	1000