

南京诺金电气有限公司

Nanjing Nowking Electric Co., Ltd

喇叭箱扣样本

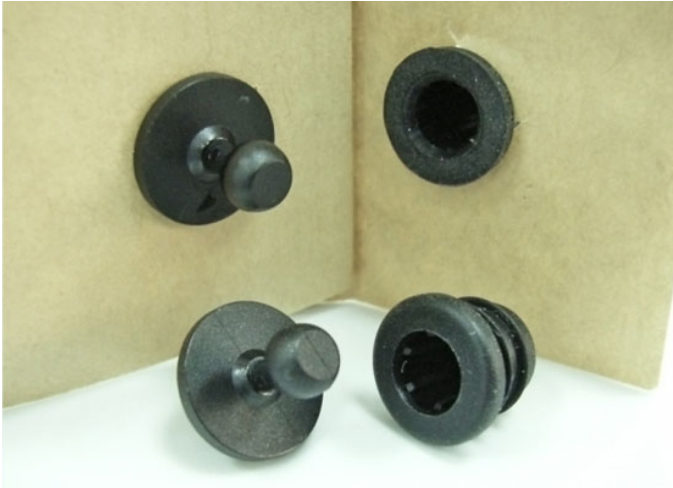

产品名称：喇叭箱扣

规格型号：SPKS01

◆ MATERIAL1:TPE

◆ MATERIAL 2: NYLON 66(UL)

◆ COLOR:BLACK

◆ UNIT: mm

用途:固定音箱外盖使用。

MATERIAL 2 为插销

SPKS01 结构图

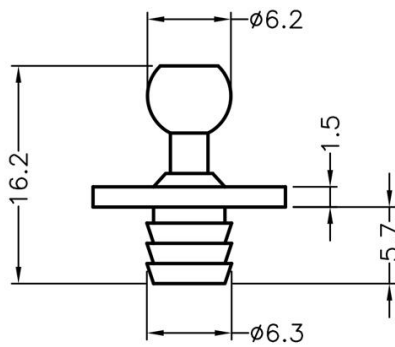

CHASSIS $\phi 6.1\text{mm}$
THICKNESS 6.4mm

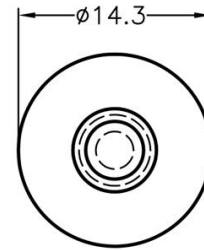

	PART NO	PACKAGE
	SPKS01	500

南京诺金电气有限公司

Nanjing Nowking Electric Co., Ltd



产品名称：喇叭箱扣

规格型号：SPKS02

- ◆ MATERIAL1:TPE
- ◆ MATERIAL 2: NYLON 66(UL)
- ◆ COLOR:BLACK
- ◆ UNIT: mm

用途:固定音箱外盖使用。

MATERIAL 2 为插销

SPKS02 结构图

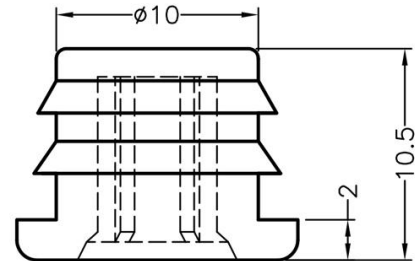
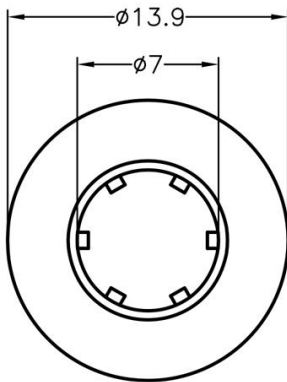

	PART NO	PACKAGE
	SPKS02	500

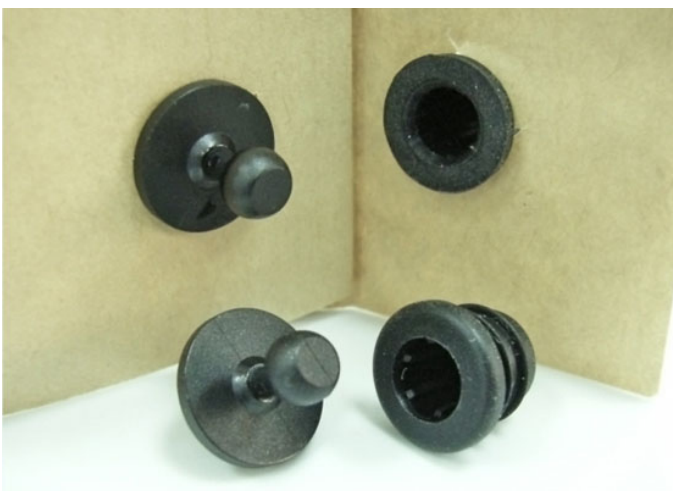

产品名称：喇叭箱扣

规格型号：SPKS03

- ◆ MATERIAL1:TPU
- ◆ MATERIAL 2: NYLON 66(UL)
- ◆ COLOR:BLACK
- ◆ UNIT: mm

用途:固定音箱外盖使用。

MATERIAL 2 为插销

SPKS03 结构图

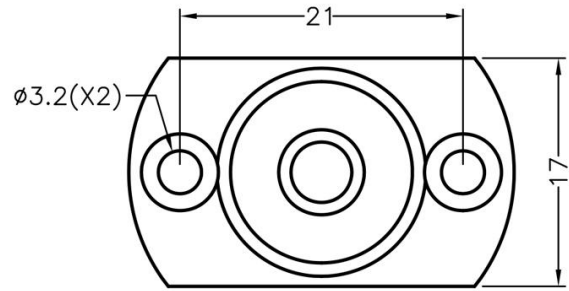
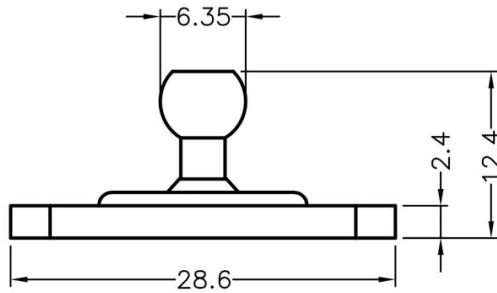

	PART NO	PACKAGE
	SPKS03	500



产品名称：喇叭箱扣

规格型号：SPKS04

- ◆ MATERIAL1:TU
 - ◆ MATERIAL 2: NYLON 66(UL)
 - ◆ COLOR:BLACK
 - ◆ UNIT: mm
- 用途:固定音箱外盖使用。

MATERIAL 2 为插销

SPKS04 结构图

南京诺金电气有限公司

Nanjing Nowking Electric Co., Ltd

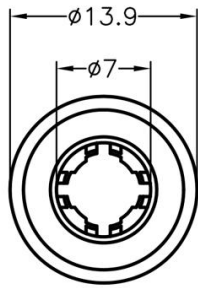

CHASSIS $\phi 10.5\text{mm}$
THICKNESS 2.5mm

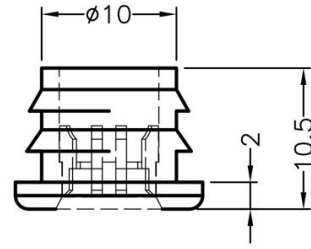

	PART NO	PACKAGE
	SPKS04	500